



COALGEN 2006

Cincinnati - USA - August 16 - 18, 2006

Ultra-Supercritical Pulverized Coal Fired Power Plants

Miro R. Susta

IMTEAG Power Consulting Engineers
Switzerland

imteag.com

CONTENT

- Energy Supply & Consumption
- Efficiency Evolution
- Coal Reserves
- ST Unit Size Evolution
- SC / USC Technology
- SC / USC Power Plants Worldwide Summary
- Efficiency Improvement
- 50 Hz RPP
- 60 Hz RPP
- OT Boiler
- Boiler Materials
- ST Configurations
- ST Materials
- Selected SC / USC Power Plants
- Summary - Conclusions

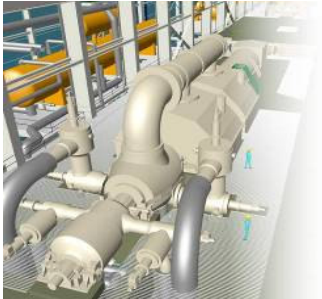



Main Concerns with Energy → Electricity Supply

➤ Affordability

Investment -  -  - O&M → Tariff



➤ Reliability

 -  - O&M → Availability

➤ Accessibility

Grid Connections → Distribution Network

➤ Environmental Acceptability

 -  - O&M → Emissions

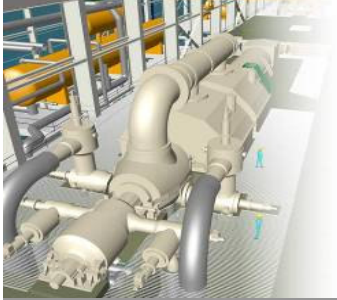

IMTE AG Power Consulting Engineers

www.imteag.com

US Electricity Power Generation History

➤ 1896 ⇒ Niagara Falls Hydro Power Plant produced 3.7MW at 2.35kV / 25Hz

Coalgen 2006

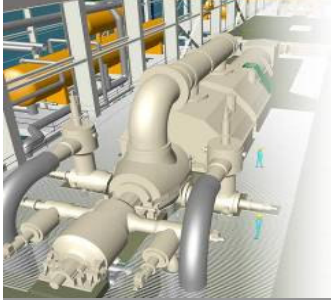

IMTE AG Power Consulting Engineers

www.imteag.com

US Electricity Power Generation History

- **1896** ⇒ Niagara Falls Hydro Power Plant produced 3.7MW at 2.35kV / 25Hz
- **1903** ⇒ 1st Commonwealth Edison Power Plant ST produced 5MW (180psi/530°F)

Coalgen 2006

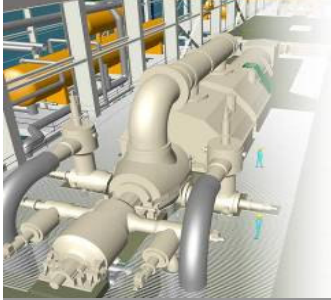

IMTE AG Power Consulting Engineers

www.imteag.com

US Electricity Power Generation History

- **1896** ⇒ Niagara Falls Hydro Power Plant produced 3.7MW at 2.35kV / 25Hz
- **1903** ⇒ 1st Commonwealth Edison Power Plant ST produced 5MW (180psi/530°F)
- **Beginning of 20th century;**
 - ❖ 20 US¢/kWh or higher
 - ❖ Available only in the cities (lighting of streets, buildings, factories supply)
 - ❖ Not affordable for most of households

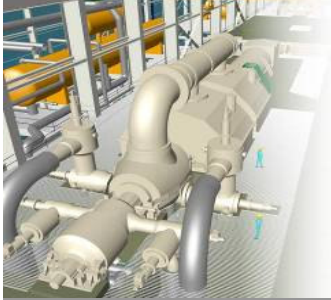

IMTE AG Power Consulting Engineers

www.imteag.com

US Electricity Power Generation History

- **1896** ⇒ Niagara Falls Hydro Power Plant produced 3.7MW at 2.35kV / 25Hz
- **1903** ⇒ 1st Commonwealth Edison Power Plant ST produced 5MW (180psi/530°F)
- **Beginning of 20th century;**
 - ❖ 20 US¢/kWh or higher
 - ❖ Available only in the cities (lighting of streets, buildings, factories supply)
 - ❖ Not affordable for most of households
- **1900 – 1920** ⇒ ST operated at 1,200rpm (20Hz); Unit Capacity up to 65MW

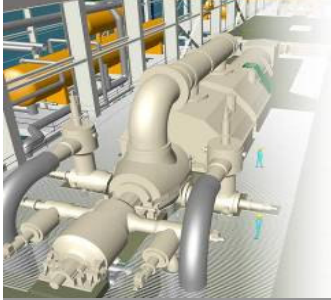

IMTE AG Power Consulting Engineers

www.imteag.com

US Electricity Power Generation History

- **1896** ⇒ Niagara Falls Hydro Power Plant produced 3.7MW at 2.35kV / 25Hz
- **1903** ⇒ 1st Commonwealth Edison Power Plant ST produced 5MW (180psi/530°F)
- **Beginning of 20th century;**
 - ❖ 20 US¢/kWh or higher
 - ❖ Available only in the cities (lighting of streets, buildings, factories supply)
 - ❖ Not affordable for most of households
- **1900 – 1920** ⇒ ST operated at 1,200rpm (20Hz); Unit Capacity up to 65MW
- **1915** ⇒ Establishment of ASME Code

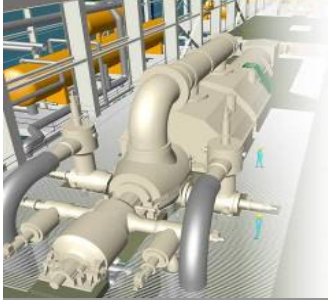

IMTE AG Power Consulting Engineers

www.imteag.com

US Electricity Power Generation History

- **1896** ⇒ Niagara Falls Hydro Power Plant produced 3.7MW at 2.35kV / 25Hz
- **1903** ⇒ 1st Commonwealth Edison Power Plant ST produced 5MW (180psi/530°F)
- **Beginning of 20th century;**
 - ❖ 20 US¢/kWh or higher
 - ❖ Available only in the cities (lighting of streets, buildings, factories supply)
 - ❖ Not affordable for most of households
- **1900 – 1920** ⇒ ST operated at 1,200rpm (20Hz); Unit Capacity up to 65MW
- **1915** ⇒ Establishment of ASME Code
- **1920 – 1935** ⇒ ST operated at 1,800rpm (30Hz); Unit Capacity up to 200MW

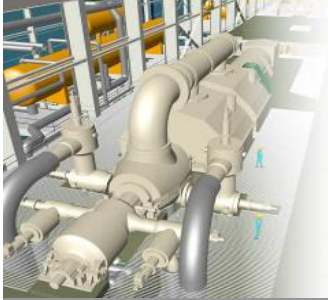

IMTE AG Power Consulting Engineers

www.imteag.com

US Electricity Power Generation History

- **1896** ⇒ Niagara Falls Hydro Power Plant produced 3.7MW at 2.35kV / 25Hz
- **1903** ⇒ 1st Commonwealth Edison Power Plant ST produced 5MW (180psi/530°F)
- **Beginning of 20th century;**
 - ❖ 20 US¢/kWh or higher
 - ❖ Available only in the cities (lighting of streets, buildings, factories supply)
 - ❖ Not affordable for most of households
- **1900 – 1920** ⇒ ST operated at 1,200rpm (20Hz); Unit Capacity up to 65MW
- **1915** ⇒ Establishment of ASME Code
- **1920 – 1935** ⇒ ST operated at 1,800rpm (30Hz); Unit Capacity up to 200MW
- **1935 – 1953** ⇒ ST operated at 3,600rpm (60Hz); Unit Capacity up to 200MW

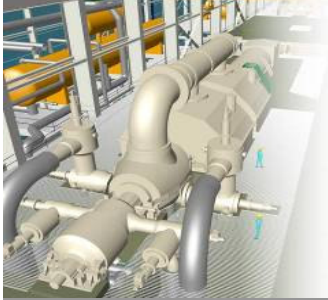

IMTE AG Power Consulting Engineers

www.imteag.com

US Electricity Power Generation History

- **1896** ⇒ Niagara Falls Hydro Power Plant produced 3.7MW at 2.35kV / 25Hz
- **1903** ⇒ 1st Commonwealth Edison Power Plant ST produced 5MW (180psi/530°F)
- **Beginning of 20th century;**
 - ❖ 20 US¢/kWh or higher
 - ❖ Available only in the cities (lighting of streets, buildings, factories supply)
 - ❖ Not affordable for most of households
- **1900 – 1920** ⇒ ST operated at 1,200rpm (20Hz); Unit Capacity up to 65MW
- **1915** ⇒ Establishment of ASME Code
- **1920 – 1935** ⇒ ST operated at 1,800rpm (30Hz); Unit Capacity up to 200MW
- **1935 – 1953** ⇒ ST operated at 3,600rpm (60Hz); Unit Capacity up to 200MW
- **1955** ⇒ 55% Power Generation from Coal; USA produced 42% World El. Power

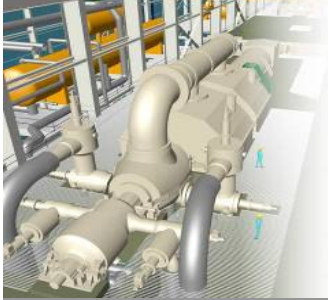

IMTE AG Power Consulting Engineers

www.imteag.com

US Electricity Power Generation History

- **1896** ⇒ Niagara Falls Hydro Power Plant produced 3.7MW at 2.35kV / 25Hz
- **1903** ⇒ 1st Commonwealth Edison Power Plant ST produced 5MW (180psi/530°F)
- **Beginning of 20th century;**
 - ❖ 20 US¢/kWh or higher
 - ❖ Available only in the cities (lighting of streets, buildings, factories supply)
 - ❖ Not affordable for most of households
- **1900 – 1920** ⇒ ST operated at 1,200rpm (20Hz); Unit Capacity up to 65MW
- **1915** ⇒ Establishment of ASME Code
- **1920 – 1935** ⇒ ST operated at 1,800rpm (30Hz); Unit Capacity up to 200MW
- **1935 – 1953** ⇒ ST operated at 3,600rpm (60Hz); Unit Capacity up to 200MW
- **1955** ⇒ 55% Power Generation from Coal; USA produced 42% World El. Power
- **1957** ⇒ 1st USC Power Plant, 120MW Philo 6 in Operation (4,500psi/1,100°F)

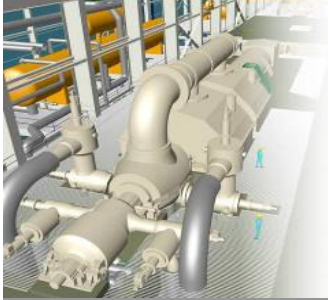

IMTE AG Power Consulting Engineers

www.imteag.com

US Electricity Power Generation History

- **1896** ⇒ Niagara Falls Hydro Power Plant produced 3.7MW at 2.35kV / 25Hz
- **1903** ⇒ 1st Commonwealth Edison Power Plant ST produced 5MW (180psi/530°F)
- **Beginning of 20th century;**
 - ❖ 20 US¢/kWh or higher
 - ❖ Available only in the cities (lighting of streets, buildings, factories supply)
 - ❖ Not affordable for most of households
- **1900 – 1920** ⇒ ST operated at 1,200rpm (20Hz); Unit Capacity up to 65MW
- **1915** ⇒ Establishment of ASME Code
- **1920 – 1935** ⇒ ST operated at 1,800rpm (30Hz); Unit Capacity up to 200MW
- **1935 – 1953** ⇒ ST operated at 3,600rpm (60Hz); Unit Capacity up to 200MW
- **1955** ⇒ 55% Power Generation from Coal; USA produced 42% World El. Power
- **1957** ⇒ 1st USC Power Plant, 120MW Philo 6 in Operation (4,500psi/1,100°F)
- **1960 – 1963** ⇒ 1st Commercial Nuclear Power Plants produce Electric Power

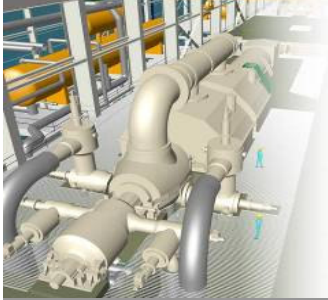

IMTE AG Power Consulting Engineers

www.imteag.com

US Electricity Power Generation History

- **1896** ⇒ Niagara Falls Hydro Power Plant produced 3.7MW at 2.35kV / 25Hz
- **1903** ⇒ 1st Commonwealth Edison Power Plant ST produced 5MW (180psi/530°F)
- **Beginning of 20th century;**
 - ❖ 20 US¢/kWh or higher
 - ❖ Available only in the cities (lighting of streets, buildings, factories supply)
 - ❖ Not affordable for most of households
- **1900 – 1920** ⇒ ST operated at 1,200rpm (20Hz); Unit Capacity up to 65MW
- **1915** ⇒ Establishment of ASME Code
- **1920 – 1935** ⇒ ST operated at 1,800rpm (30Hz); Unit Capacity up to 200MW
- **1935 – 1953** ⇒ ST operated at 3,600rpm (60Hz); Unit Capacity up to 200MW
- **1955** ⇒ 55% Power Generation from Coal; USA produced 42% World El. Power
- **1957** ⇒ 1st USC Power Plant, 120MW Philo 6 in Operation (4,500psi/1,100°F)
- **1960 – 1963** ⇒ 1st Commercial Nuclear Power Plants produce Electric Power
- **1980** ⇒ Large STs reached Unit Capacity up to 1,300MW

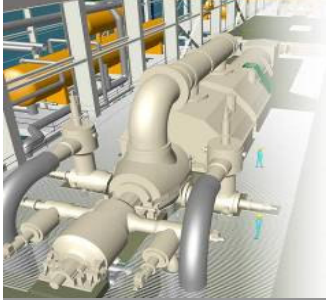

US Electricity Power Generation History

- **1896** ⇒ Niagara Falls Hydro Power Plant produced 3.7MW at 2.35kV / 25Hz
- **1903** ⇒ 1st Commonwealth Edison Power Plant ST produced 5MW (180psi/530°F)
- **Beginning of 20th century;**
 - ❖ 20 US¢/kWh or higher
 - ❖ Available only in the cities (lighting of streets, buildings, factories supply)
 - ❖ Not affordable for most of households
- **1900 – 1920** ⇒ ST operated at 1,200rpm (20Hz); Unit Capacity up to 65MW
- **1915** ⇒ Establishment of ASME Code
- **1920 – 1935** ⇒ ST operated at 1,800rpm (30Hz); Unit Capacity up to 200MW
- **1935 – 1953** ⇒ ST operated at 3,600rpm (60Hz); Unit Capacity up to 200MW
- **1955** ⇒ 55% Power Generation from Coal; USA produced 42% World El. Power
- **1957** ⇒ 1st USC Power Plant, 120MW Philo 6 in Operation (4,500psi/1,100°F)
- **1960 – 1963** ⇒ 1st Commercial Nuclear Power Plants produce Electric Power
- **1980** ⇒ Large STs reached Unit Capacity up to 1,300MW
- **1900 – 1980**
 - ❖ kWh-Costs decreased every decade
 - ❖ Generating Capacity doubled every 8 – 12 years

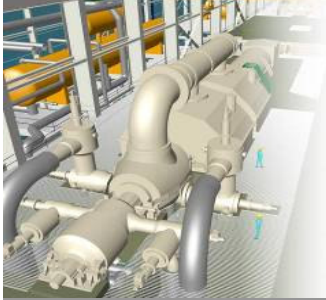

US Electricity Power Generation History

- **1896** ⇒ Niagara Falls Hydro Power Plant produced 3.7MW at 2.35kV / 25Hz
- **1903** ⇒ 1st Commonwealth Edison Power Plant ST produced 5MW (180psi/530°F)
- **Beginning of 20th century;**
 - ❖ 20 US¢/kWh or higher
 - ❖ Available only in the cities (lighting of streets, buildings, factories supply)
 - ❖ Not affordable for most of households
- **1900 – 1920** ⇒ ST operated at 1,200rpm (20Hz); Unit Capacity up to 65MW
- **1915** ⇒ Establishment of ASME Code
- **1920 – 1935** ⇒ ST operated at 1,800rpm (30Hz); Unit Capacity up to 200MW
- **1935 – 1953** ⇒ ST operated at 3,600rpm (60Hz); Unit Capacity up to 200MW
- **1955** ⇒ 55% Power Generation from Coal; USA produced 42% World El. Power
- **1957** ⇒ 1st USC Power Plant, 120MW Philo 6 in Operation (4,500psi/1,100°F)
- **1960 – 1963** ⇒ 1st Commercial Nuclear Power Plants produce Electric Power
- **1980** ⇒ Large STs reached Unit Capacity up to 1,300MW
- **1900 – 1980**
 - ❖ kWh-Costs decreased every decade
 - ❖ Generating Capacity doubled every 8 – 12 years
- **End of 20th century** ⇒ Golden Times for NG fired CCGT Power Plants



IMTE AG Power Consulting Engineers

www.imteag.com

US Electricity Power Generation History

- **1896** ⇒ Niagara Falls Hydro Power Plant produced 3.7MW at 2.35kV / 25Hz
- **1903** ⇒ 1st Commonwealth Edison Power Plant ST produced 5MW (180psi/530°F)
- **Beginning of 20th century;**
 - ❖ 20 US¢/kWh or higher
 - ❖ Available only in the cities (lighting of streets, buildings, factories supply)
 - ❖ Not affordable for most of households
- **1900 – 1920** ⇒ ST operated at 1,200rpm (20Hz); Unit Capacity up to 65MW
- **1915** ⇒ Establishment of ASME Code
- **1920 – 1935** ⇒ ST operated at 1,800rpm (30Hz); Unit Capacity up to 200MW
- **1935 – 1953** ⇒ ST operated at 3,600rpm (60Hz); Unit Capacity up to 200MW
- **1955** ⇒ 55% Power Generation from Coal; USA produced 42% World El. Power
- **1957** ⇒ 1st USC Power Plant, 120MW Philo 6 in Operation (4,500psi/1,100°F)
- **1960 – 1963** ⇒ 1st Commercial Nuclear Power Plants produce Electric Power
- **1980** ⇒ Large STs reached Unit Capacity up to 1,300MW
- **1900 – 1980**
 - ❖ kWh-Costs decreased every decade
 - ❖ Generating Capacity doubled every 8 – 12 years
- **End of 20th century** ⇒ Golden Times for NG fired CCGT Power Plants
- **2006** ⇒ Overall Power Generation 835GW (≈460GW from Coal)

Coalgen 2006

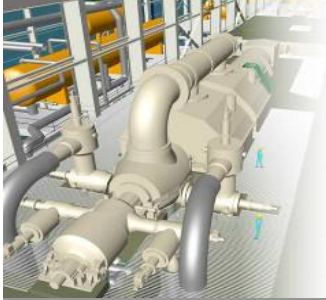

US Electricity Power Generation History

- **1896** ⇒ Niagara Falls Hydro Power Plant produced 3.7MW at 2.35kV / 25Hz
- **1903** ⇒ 1st Commonwealth Edison Power Plant ST produced 5MW (180psi/530°F)
- **Beginning of 20th century;**
 - ❖ 20 US¢/kWh or higher
 - ❖ Available only in the cities (lighting of streets, buildings, factories supply)
 - ❖ Not affordable for most of households
- **1900 – 1920** ⇒ ST operated at 1,200rpm (20Hz); Unit Capacity up to 65MW
- **1915** ⇒ Establishment of ASME Code
- **1920 – 1935** ⇒ ST operated at 1,800rpm (30Hz); Unit Capacity up to 200MW
- **1935 – 1953** ⇒ ST operated at 3,600rpm (60Hz); Unit Capacity up to 200MW
- **1955** ⇒ 55% Power Generation from Coal; USA produced 42% World El. Power
- **1957** ⇒ 1st USC Power Plant, 120MW Philo 6 in Operation (4,500psi/1,100°F)
- **1960 – 1963** ⇒ 1st Commercial Nuclear Power Plants produce Electric Power
- **1980** ⇒ Large STs reached Unit Capacity up to 1,300MW
- **1900 – 1980**
 - ❖ kWh-Costs decreased every decade
 - ❖ Generating Capacity doubled every 8 – 12 years
- **End of 20th century** ⇒ Golden Times for NG fired CCGT Power Plants
- **2006** ⇒ Overall Power Generation Capacity was 835GW (≈460GW from Coal)

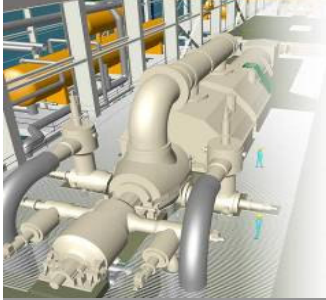

US Electricity Power Generation History

- **1896** ⇒ Niagara Falls Hydro Power Plant produced 3.7MW at 2.35kV / 25Hz
- **1903** ⇒ 1st Commonwealth Edison Power Plant ST produced 5MW (180psi/530°F)
- **Beginning of 20th century;**
 - ❖ 20 US¢/kWh or higher
 - ❖ Available only in the cities (lighting of streets, buildings, factories supply)
 - ❖ Not affordable for most of households
- **1900 – 1920** ⇒ ST operated at 1,200rpm (20Hz); Unit Capacity up to 65MW
- **1915** ⇒ Establishment of ASME Code
- **1920 – 1935** ⇒ ST operated at 1,800rpm (30Hz); Unit Capacity up to 200MW
- **1935 – 1953** ⇒ ST operated at 3,600rpm (60Hz); Unit Capacity up to 200MW
- **1955** ⇒ 55% Power Generation from Coal; USA produced 42% World El. Power
- **1957** ⇒ 1st USC Power Plant, 120MW Philo 6 in Operation (4,500psi/1,100°F)
- **1960 – 1963** ⇒ 1st Commercial Nuclear Power Plants produce Electric Power
- **1980** ⇒ Large STs reached Unit Capacity up to 1,300MW
- **1900 – 1980**
 - ❖ kWh-Costs decreased every decade
 - ❖ Generating Capacity doubled every 8 – 12 years
- **End of 20th century** ⇒ Golden Times for NG fired CCGT Power Plants
- **2006** ⇒ Overall Power Generation Capacity was 835GW (≈460GW from Coal)

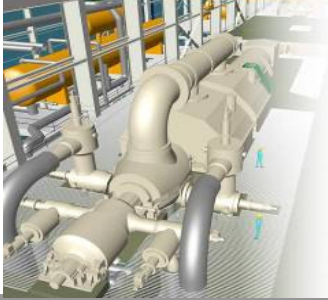

IMTE AG Power Consulting Engineers

www.imteag.com

Breaking News

96,314GWh/Week



716 GW
(PLF 80%)

Coalgen 2006

© IMTE

According to the Edison Electric Institute's weekly survey, US demand for electricity reached an all-time record 3 weeks ago amid a national heat wave as US utilities delivered **96,314 GWh of electricity for the week ending July 22, surpassing by more than 1% last year's record of 95,259 GWh.**

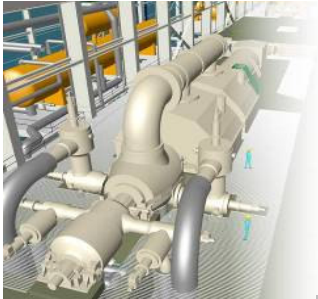

IMTE AG Power Consulting Engineers

www.imteag.com

Worldwide Overall Energy Consumption

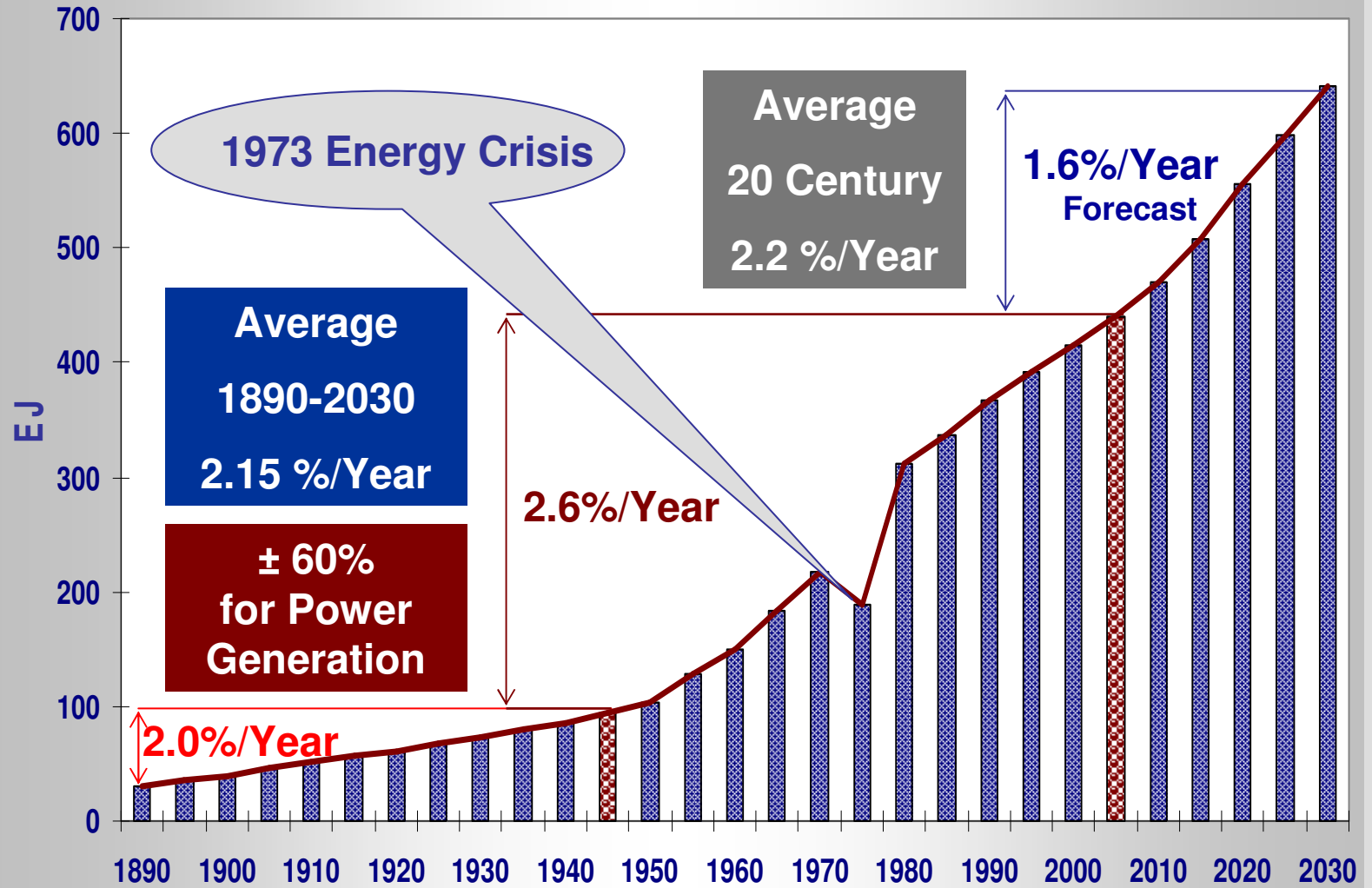

1Exajoule (EJ) =
 10^{18} Joule
 0.948×10^{15} Btu

Coalgen 2006

© IMTE

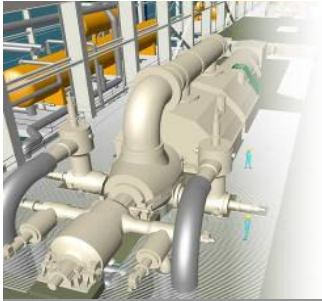

IMTE AG Power Consulting Engineers

www.imteag.com

Worldwide Overall Energy Consumption for Power Generation

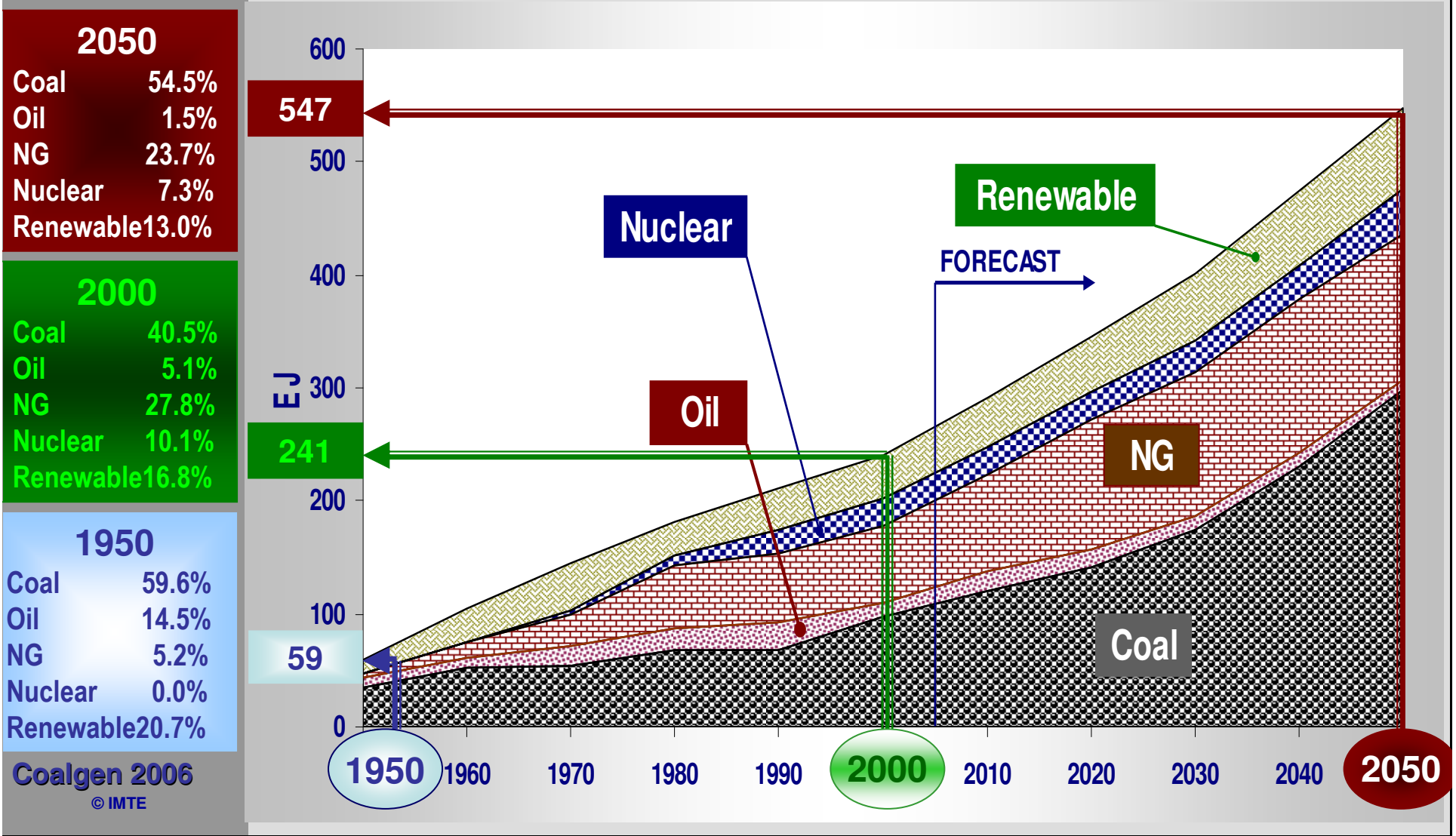

Coalgen 2006
© IMTE

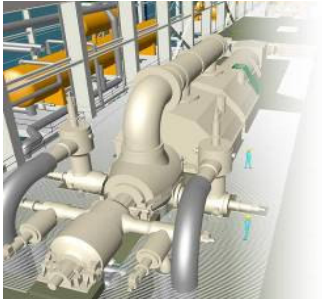

Worldwide Power Generation Energy Sources

2006

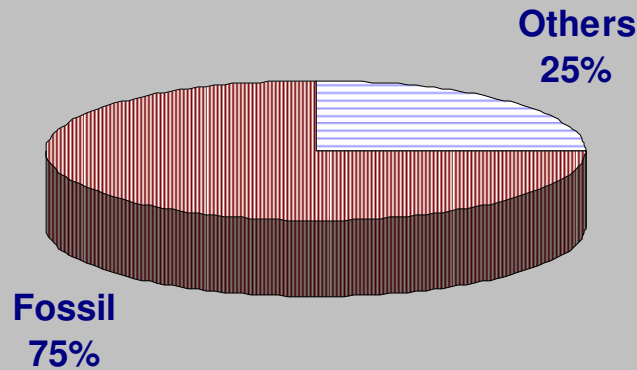

Others

- ⇒ Nuclear
- ⇒ Geothermal
- ⇒ Hydro
- ⇒ Other Renewable

Fossil

- ⇒ Coal
- ⇒ Natural Gas
- ⇒ Fuel Oil

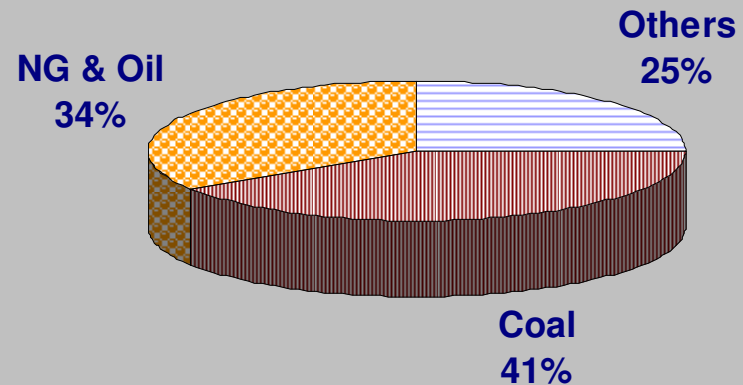

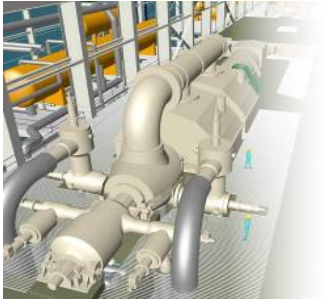

IMTE AG Power Consulting Engineers

www.imteag.com

USA Power Generation Energy Sources

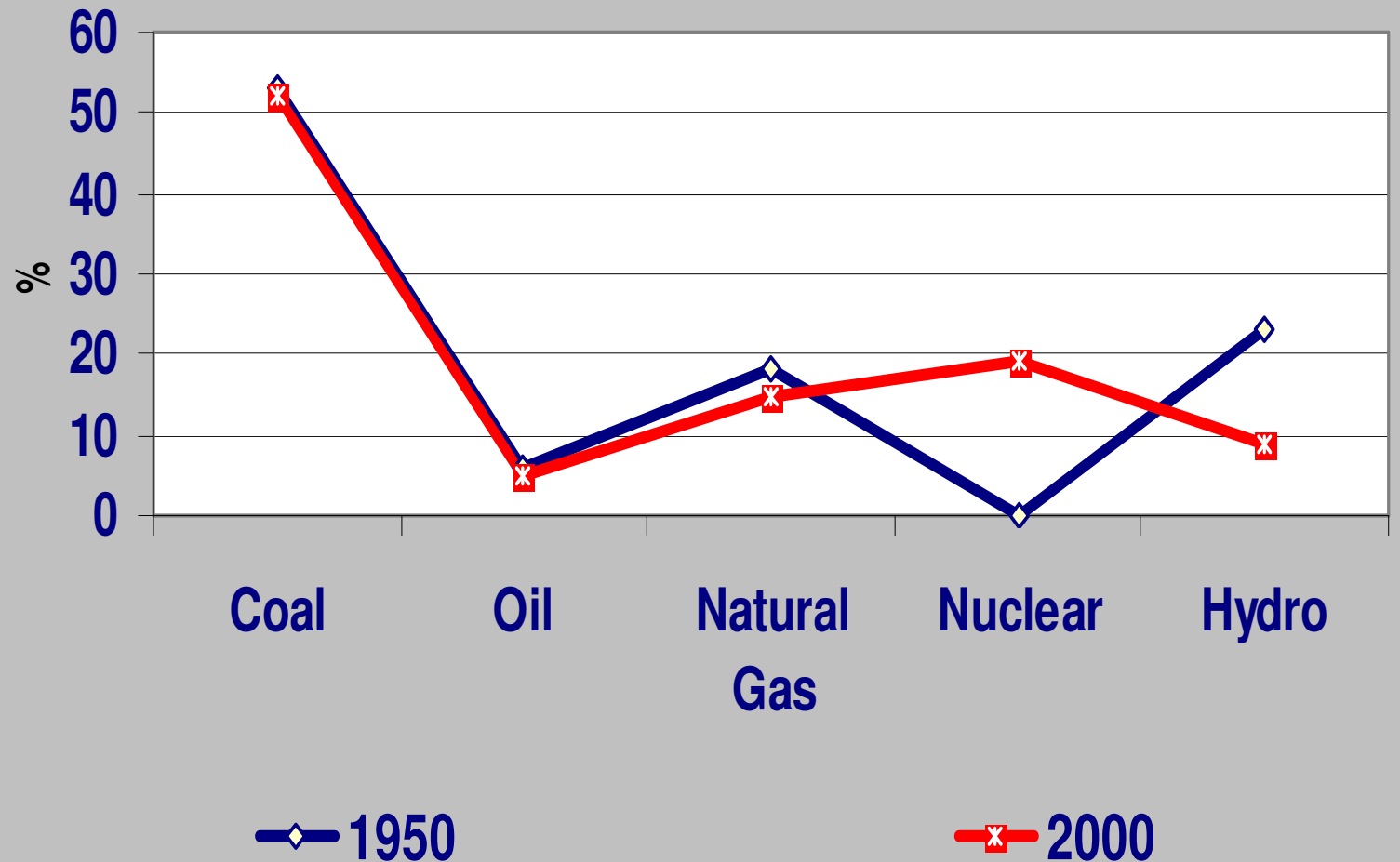

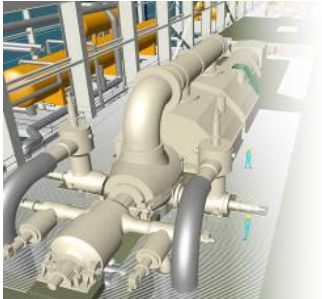

IMTE AG Power Consulting Engineers

www.imteag.com

Coal Fired Power Generation Efficiency Evolution

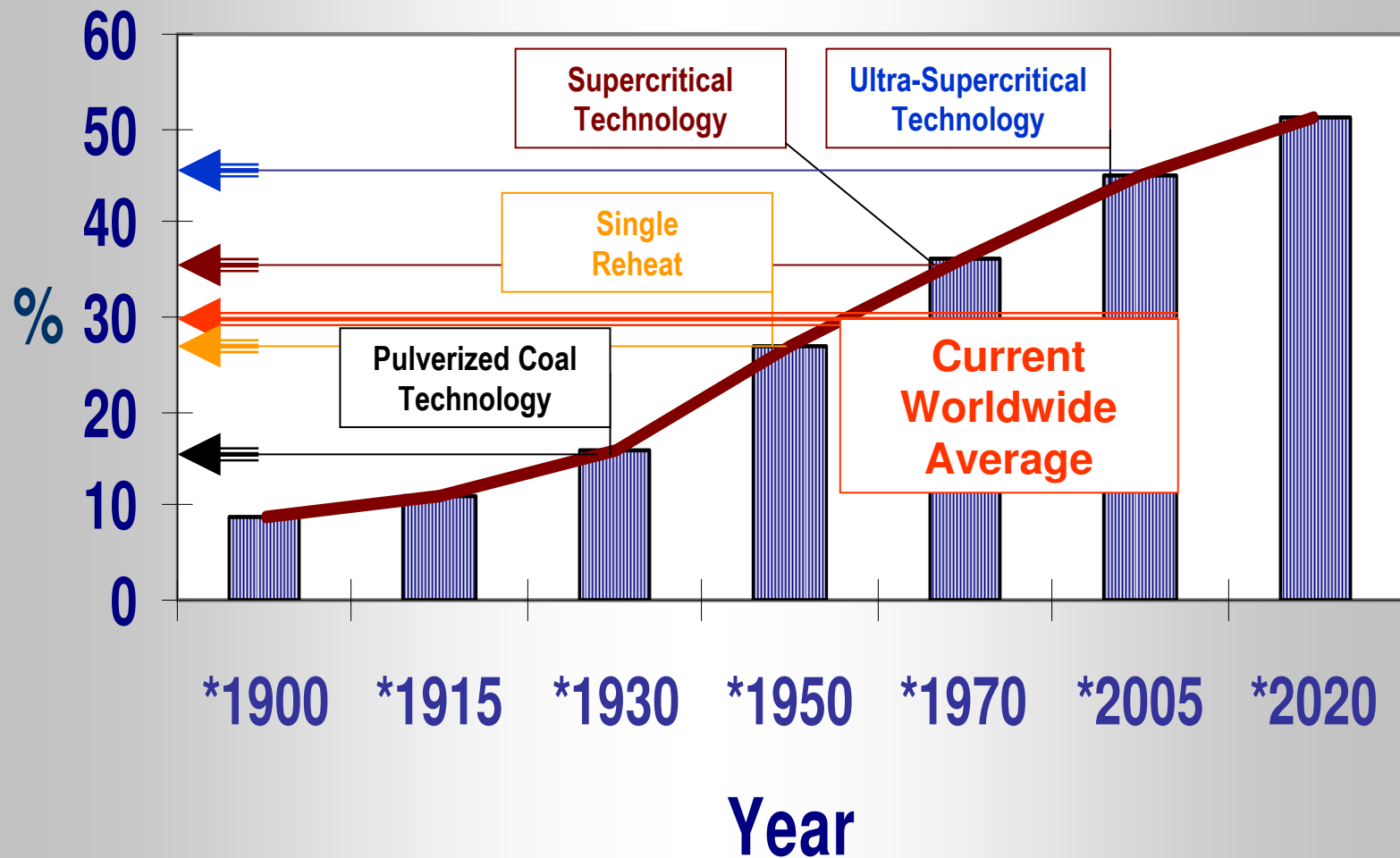

Coalgen 2006

© IMTE

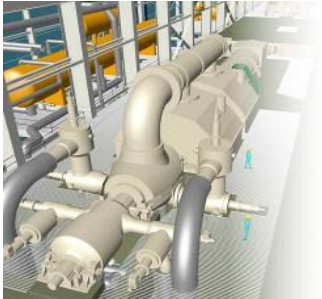

IMTE AG Power Consulting Engineers

www.imteag.com

Worldwide Present & Projected Future Coal Reserves

Reserves in 2005

1,000 Billions Short Tons

Annual Consumption (2005)

4 Billions Short Tons

250 Years

Projected Reserves in 2030

30% Efficiency Scenario

138 Years

Projected Reserves in 2030

40% Efficiency Scenario

190 Years

1 Short Ton=
0.907 M Ton

Coalgen 2006

© IMTE

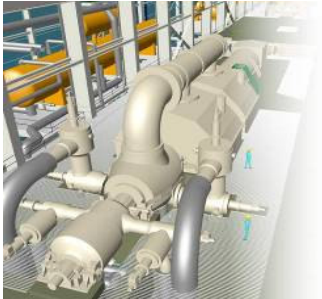

IMTE AG Power Consulting Engineers

www.imteag.com

1,000MW**10,800Btu/lb (6,000kcal/kg)

50USD/ton (2.1USD/MioBtu)**PLF=80%

1% Improvement
40%→41%

Coal Savings vs. Efficiency Improvement

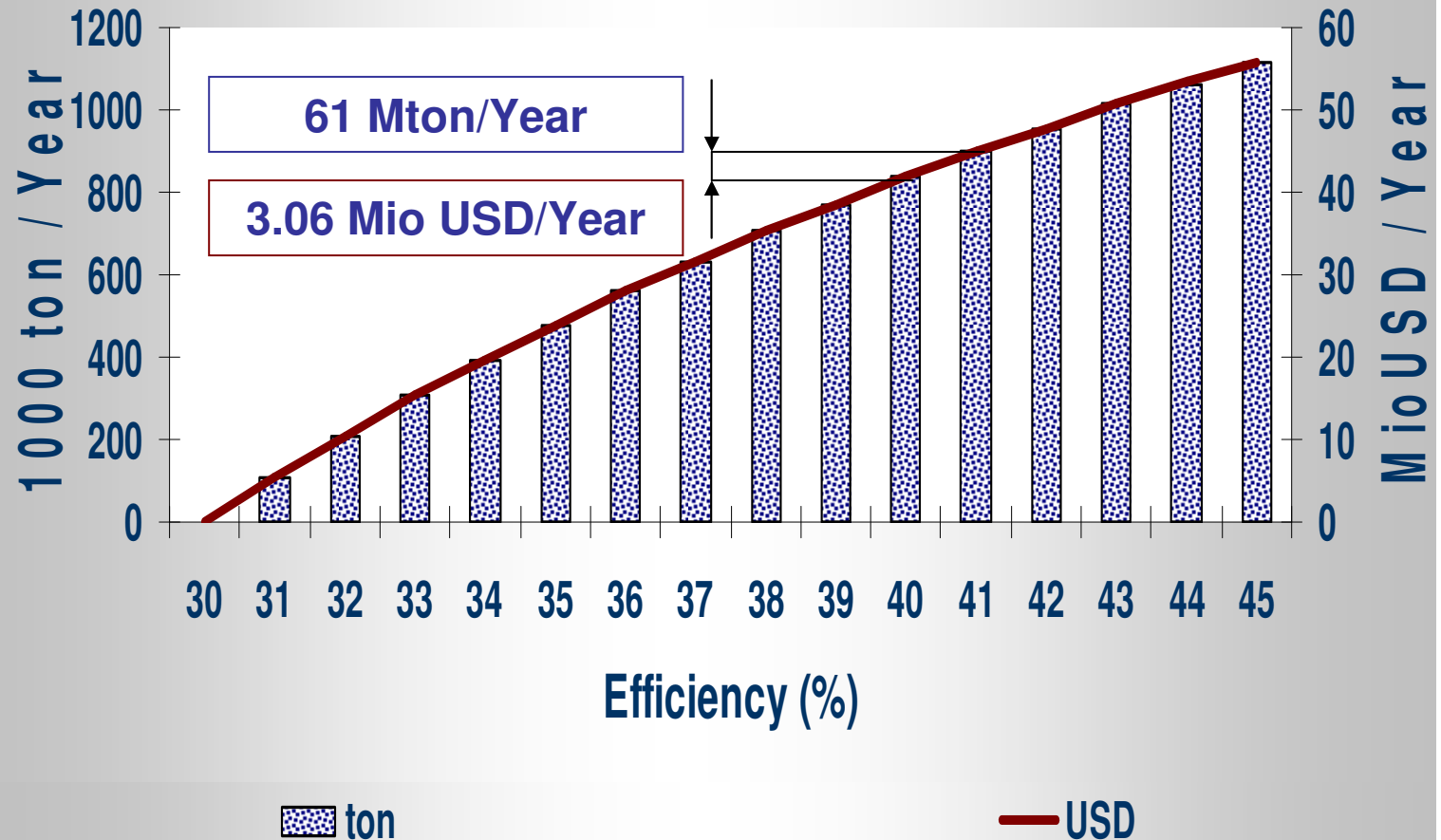

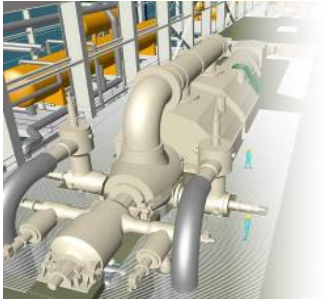

IMTE AG Power Consulting Engineers

www.imteag.com

Evolution of ST Unit Size

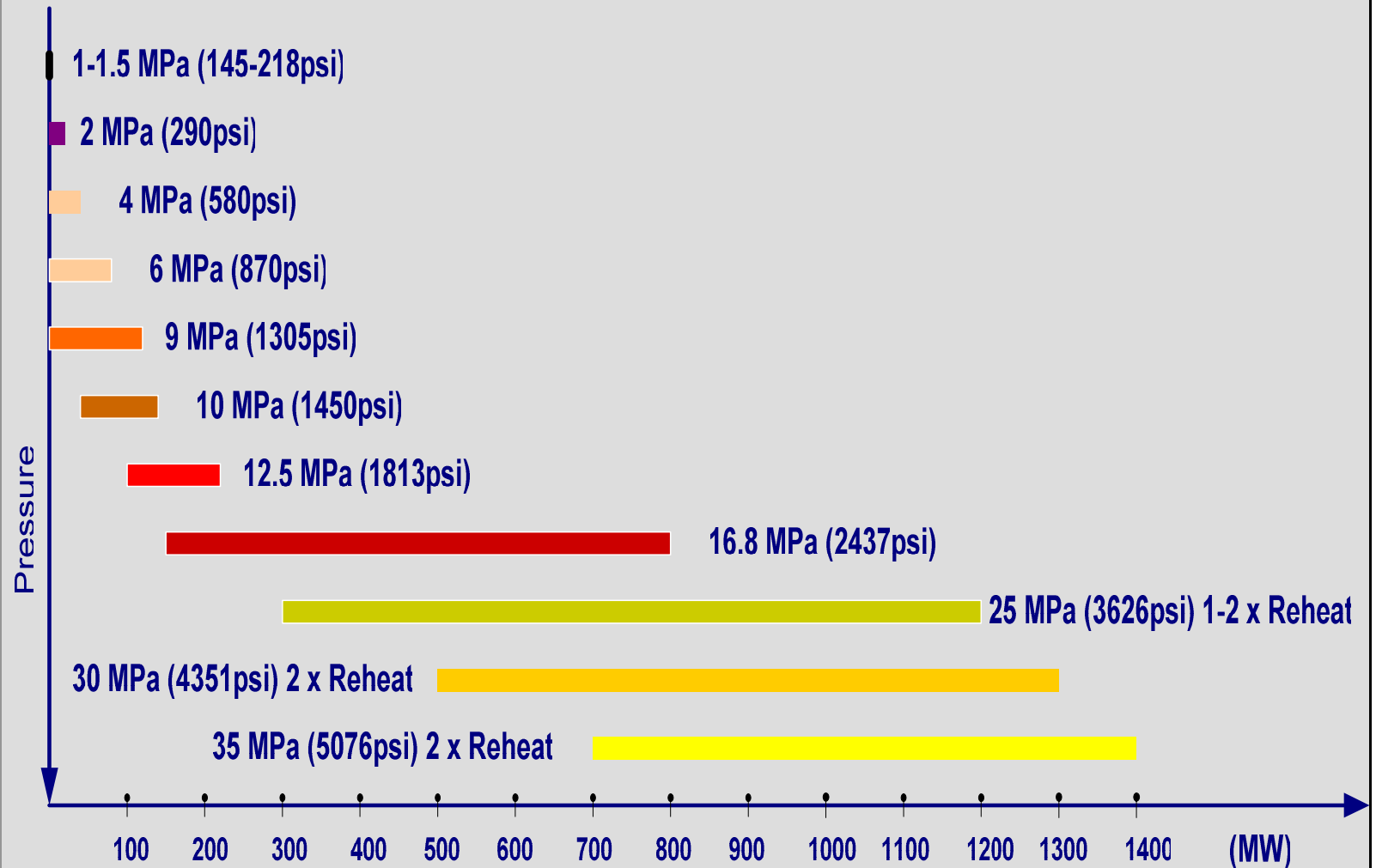

Coalgen 2006

© IMTE

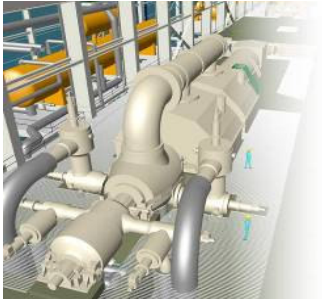

IMTE AG Power Consulting Engineers

www.imteag.com

ST Unit Configuration

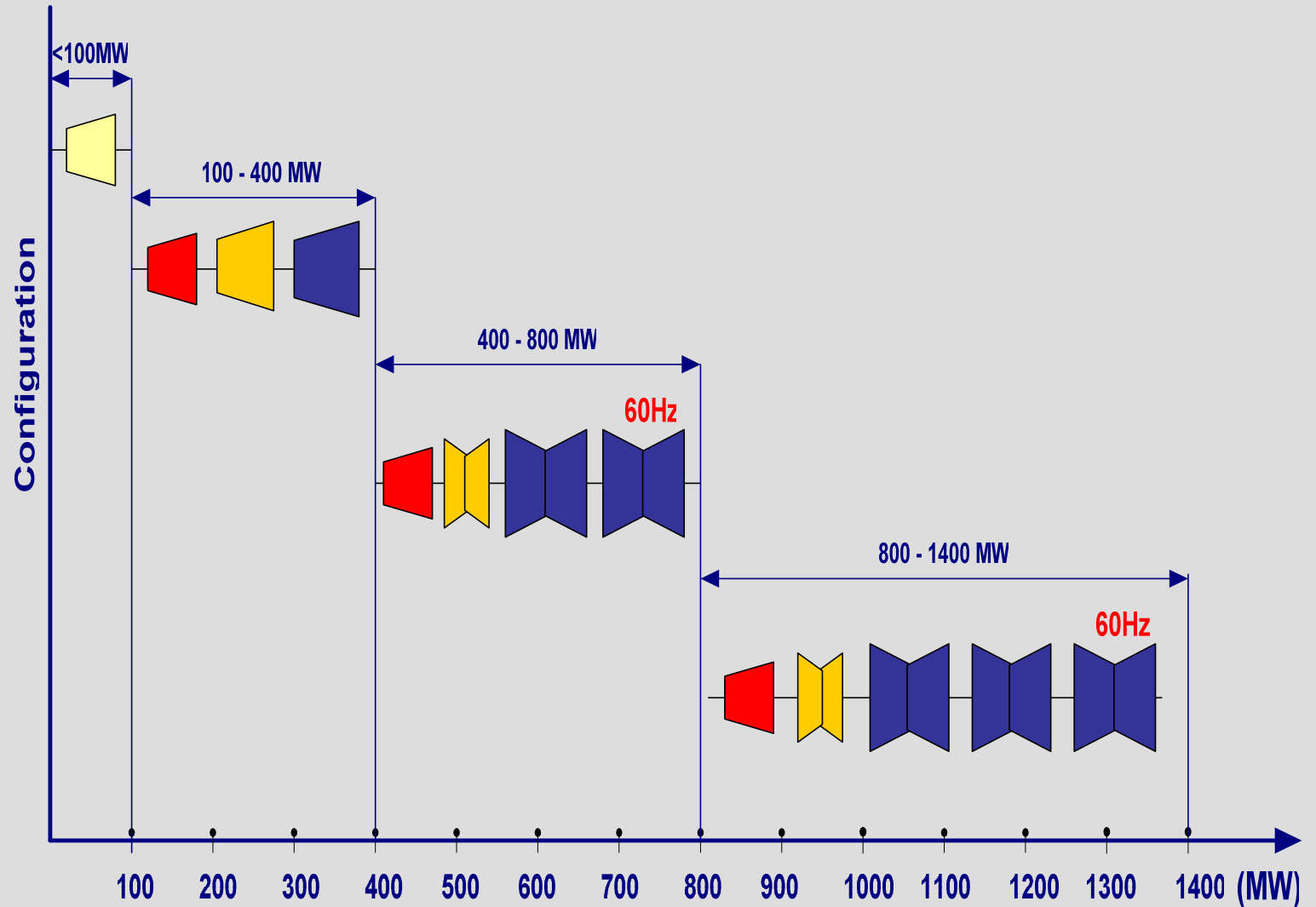

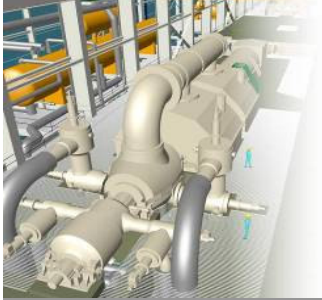

IMTE AG Power Consulting Engineers
www.imteag.com

Supercritical Water-Steam Cycle Technology

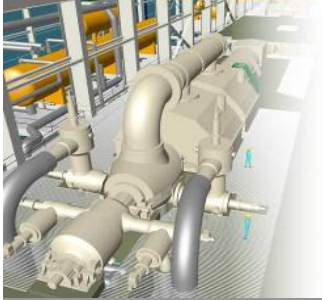

Supercritical is a thermodynamic expression describing the state of a fluid above a certain pressure when there exists no clear distinction between the liquid and gaseous phases.

> 22.064 MPa (3,200 psi)

> 374.81 °C (706.66 °F)

One of the primary means of increasing the efficiency of steam power plants is to increase live steam pressures to super- or ultra-supercritical conditions.

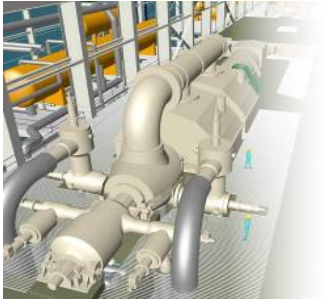

IMTE AG Power Consulting Engineers

www.imteag.com

Heat Transfer Subcritical vs. Supercritical Cycle

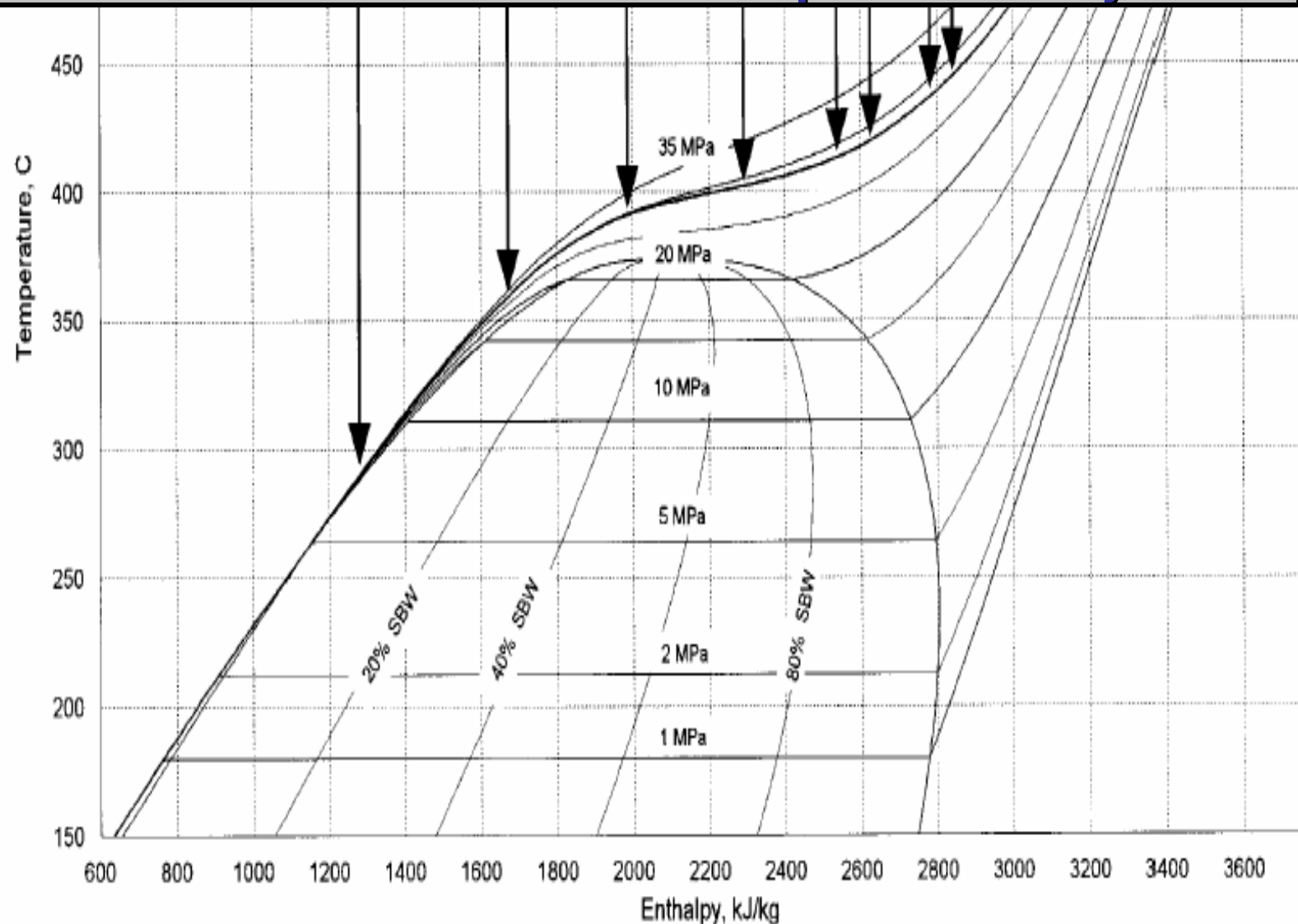

Coalgen 2006

© IMTE

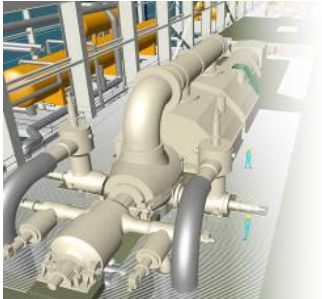

IMTE AG Power Consulting Engineers

www.imteag.com

Heat Transfer Subcritical vs. Supercritical Cycle

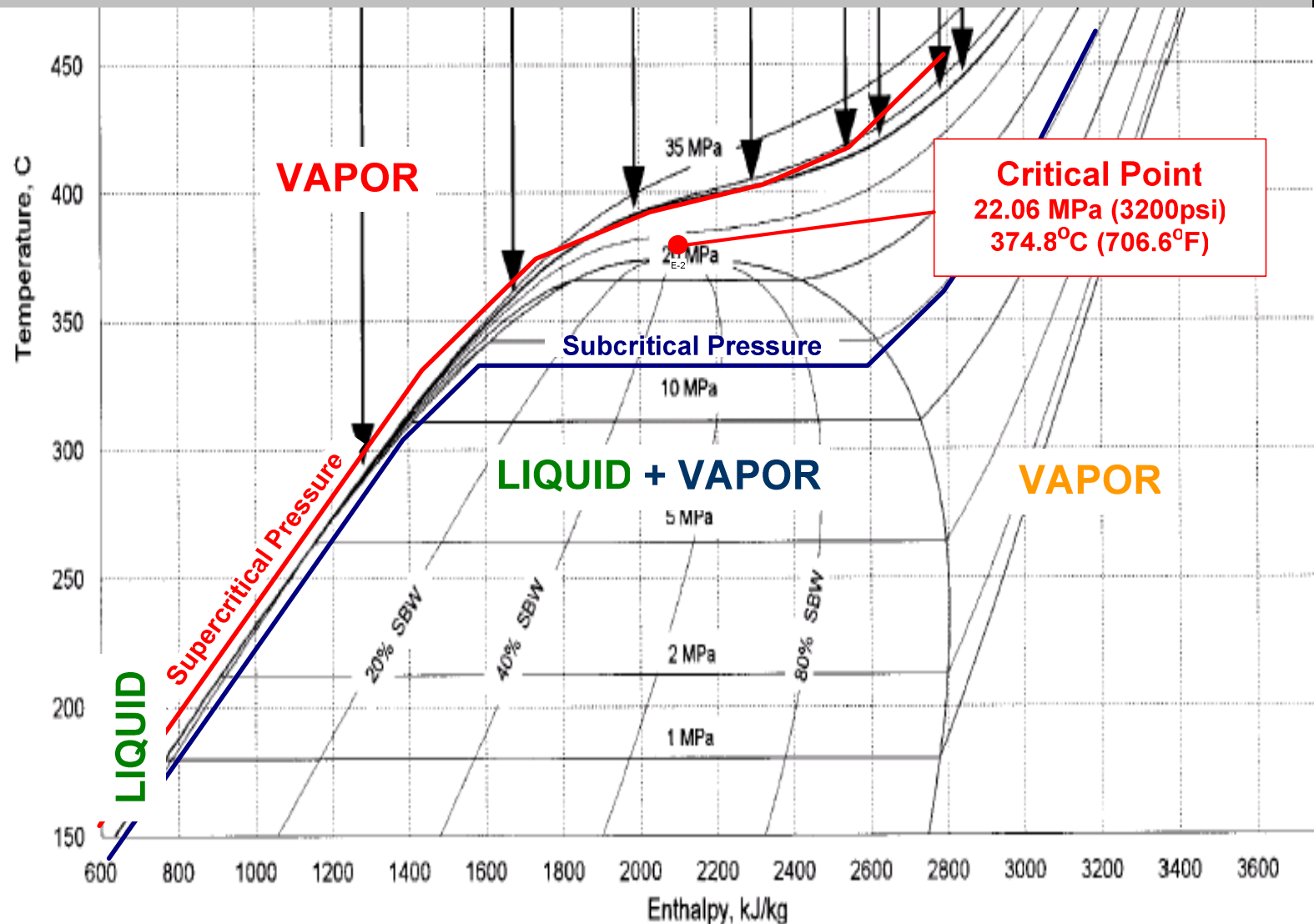

Coalgen 2006

© IMTE

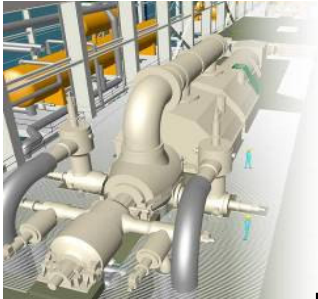

IMTE AG Power Consulting Engineers

www.imteag.com

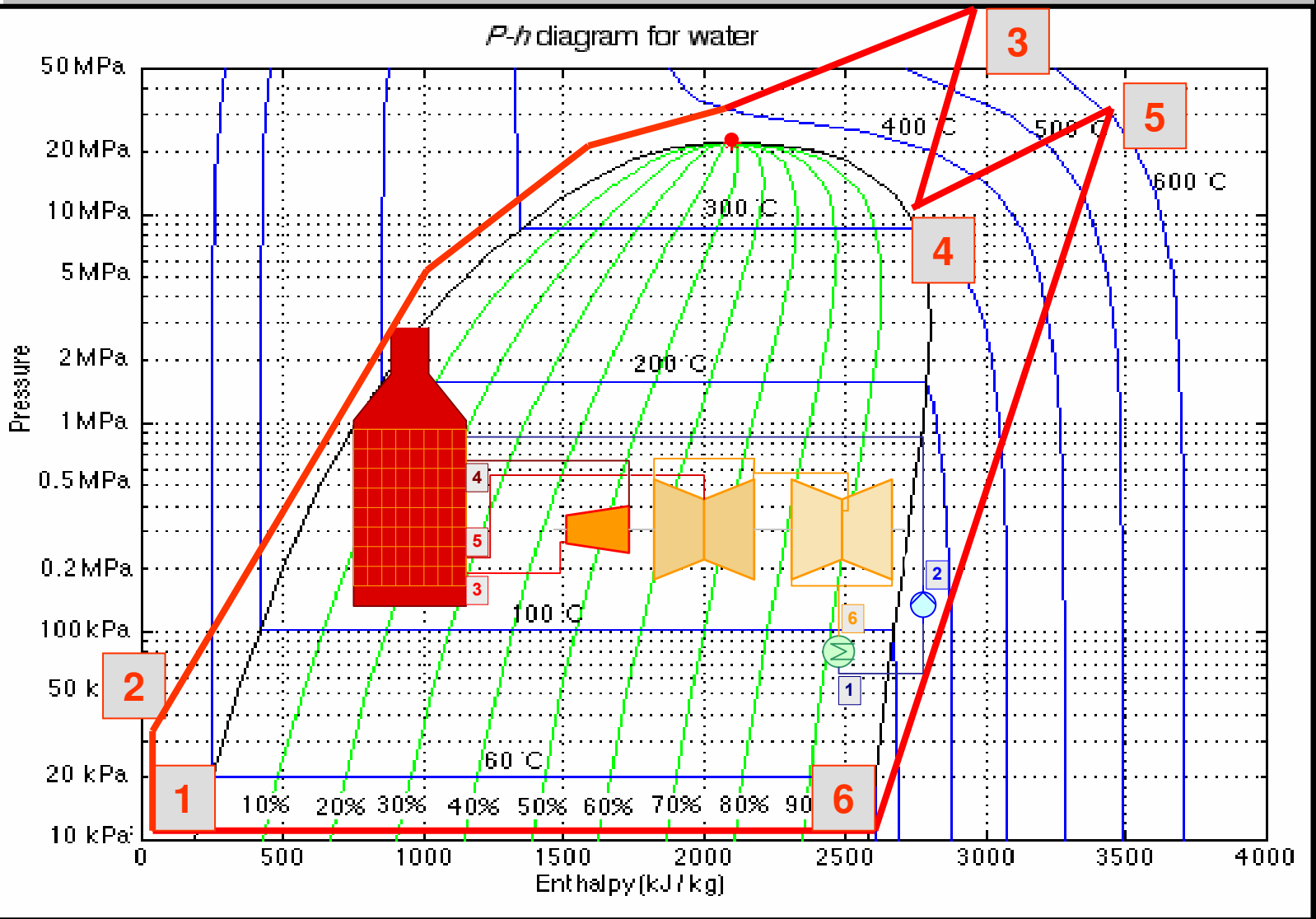



IMTE AG Power Consulting Engineers

www.imteag.com

Number of SC/USC Power Plants Worldwide

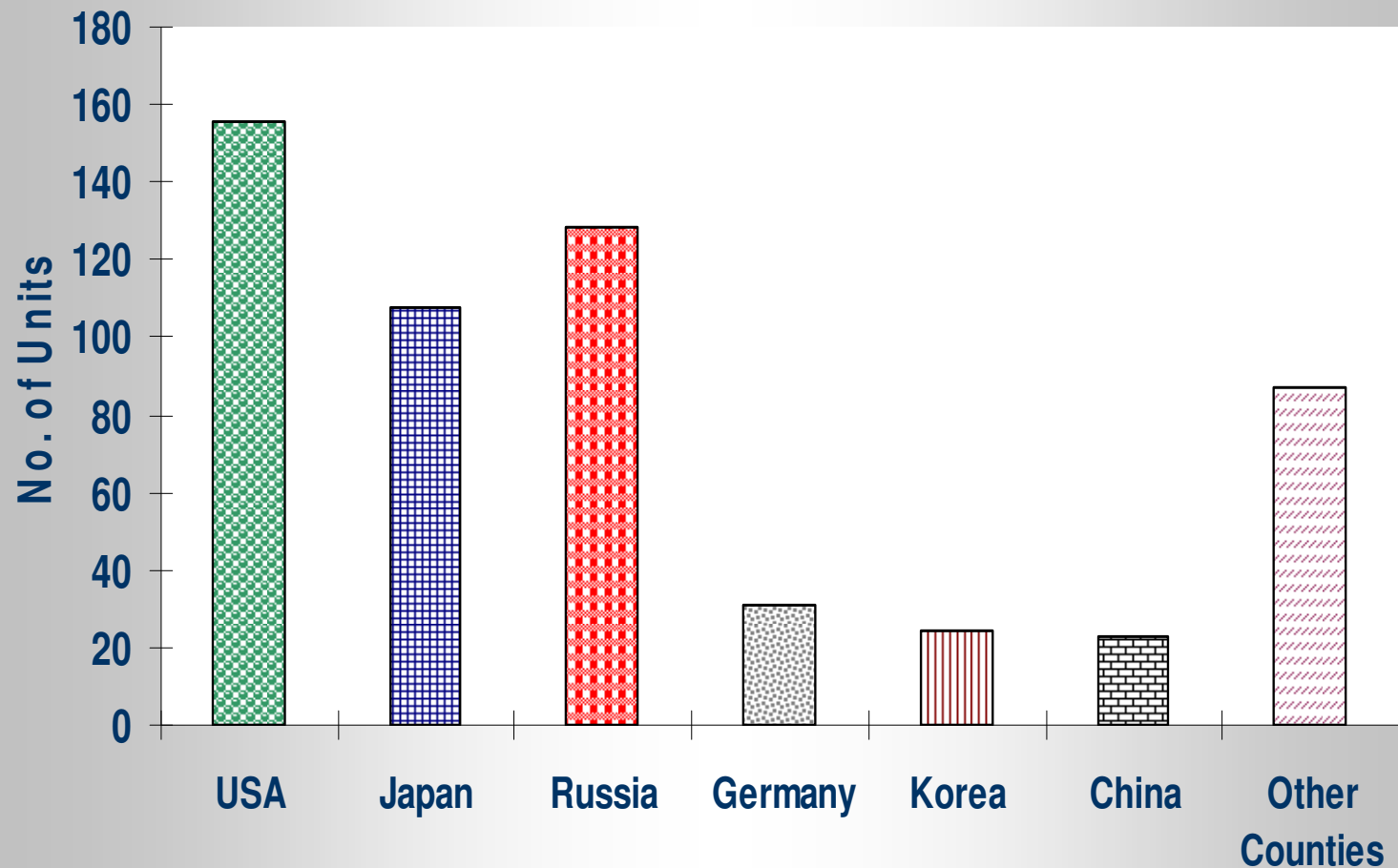

Coalgen 2006
© IMTE

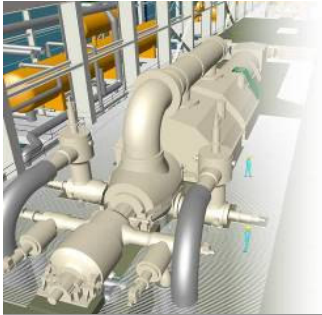

IMTE AG Power Consulting Engineers

www.imteag.com

Number and Capacity of SC/USC Power Plants

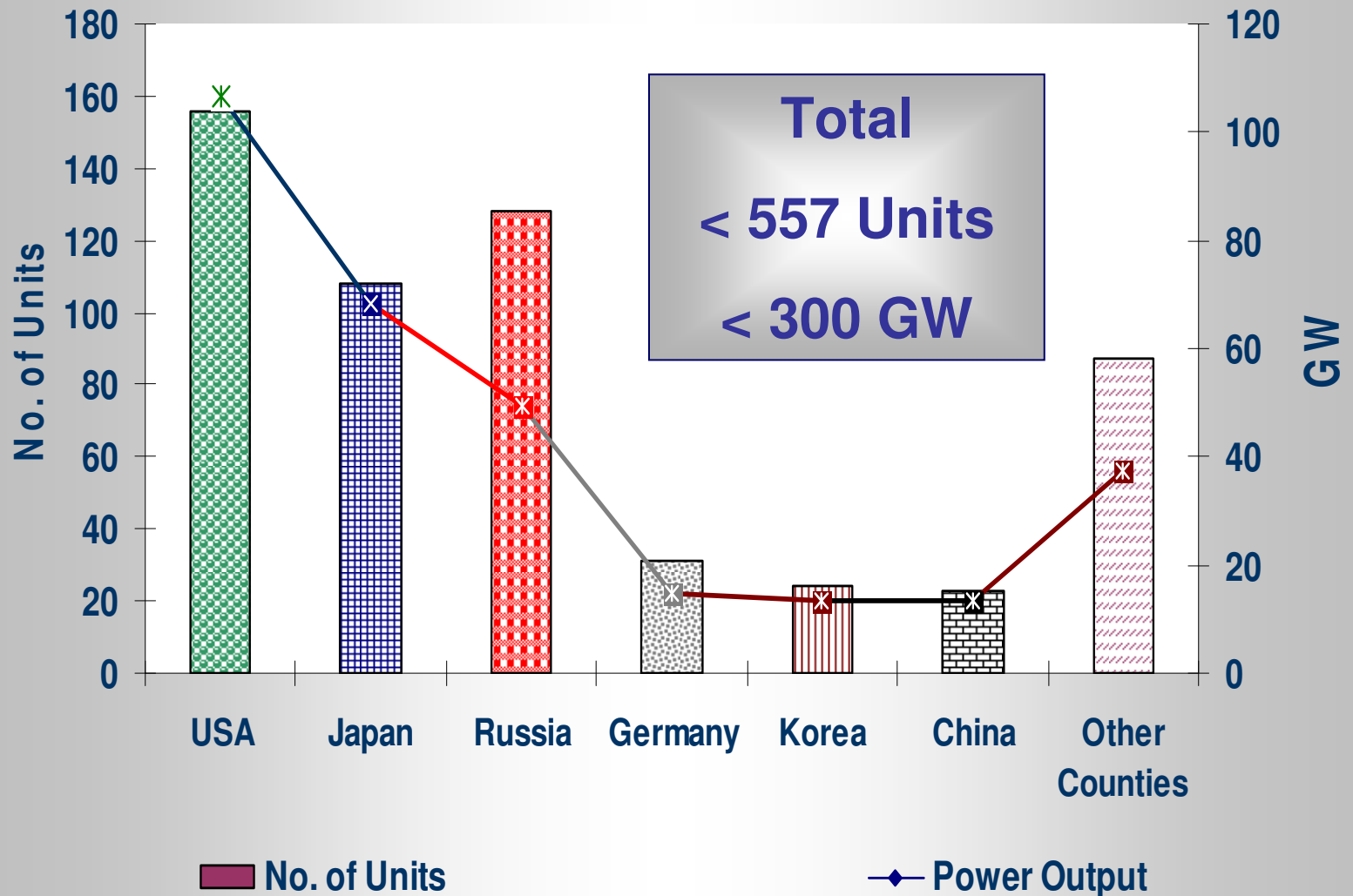



IMTE AG Power Consulting Engineers

www.imteag.com

Potential in Increase of Net Efficiency

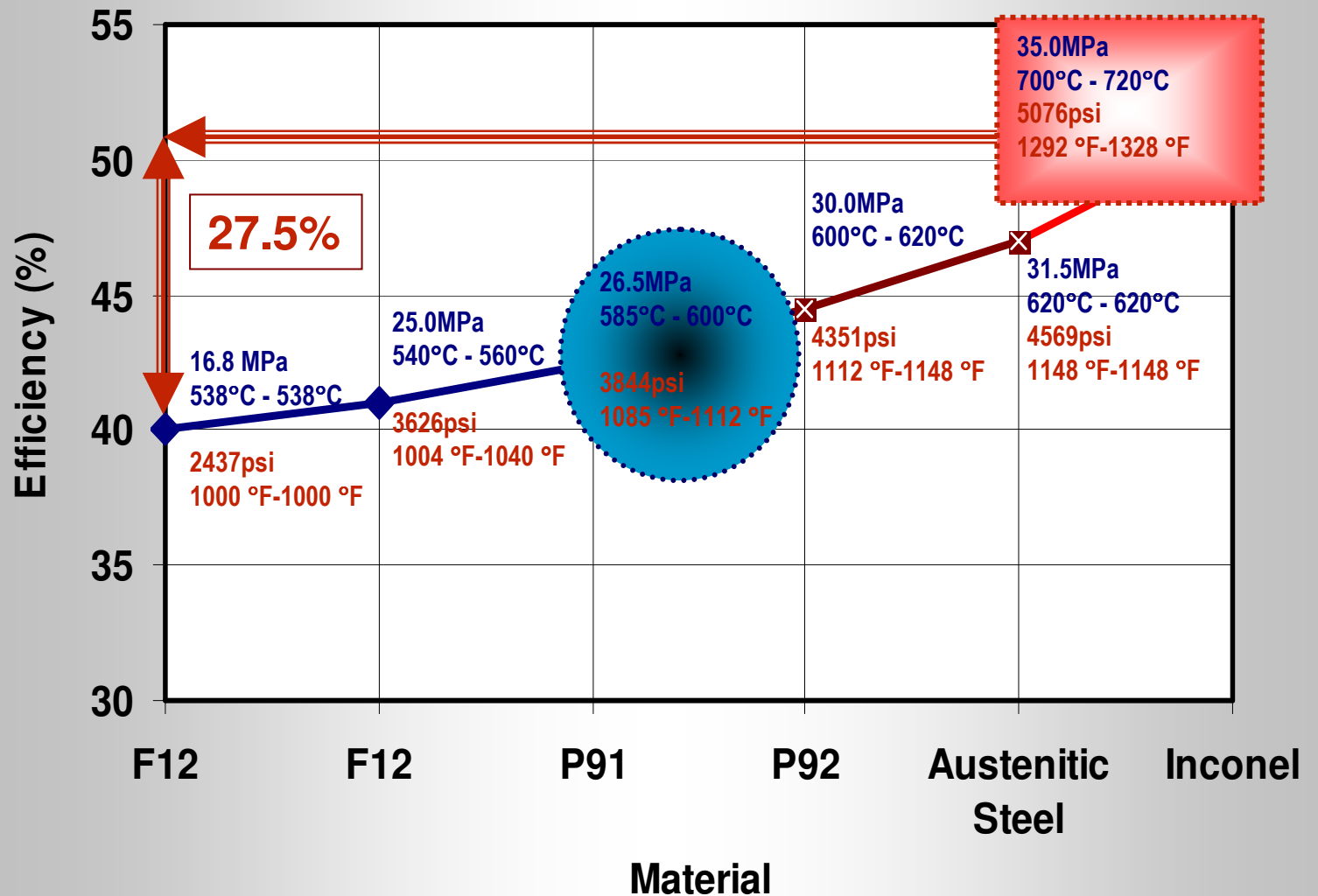

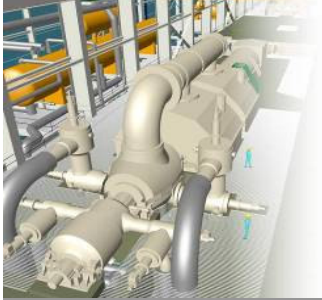

50Hz RPP – Main Parameters

- **Plant Gross Capacity** 600 MW
- **Plant Net Capacity** 552 MW
- **Live Steam Pressure** 28.5 MPa → 4134 psi
- **Live Steam Temperature** 600 °C → 1112 °F
- **Reheat Pressure** 6.0 MPa → 870 psi
- **Condenser Pressure** 4.5 kPa → 0.653 psi
- **Feed Water Temperature** 303 °C → 578 °F
- **Reheat Temperature** 620 °C → 1148 °F
- **Heat Rate_{NET/LHV}–Efficiency** 7,433.8 Btu/kWh – 45.9 %
- **Boiler Type** OT-Benson
- **ST Type** 3 Casing – Single Reheat
1SF HP-1DF IP-1DF LP

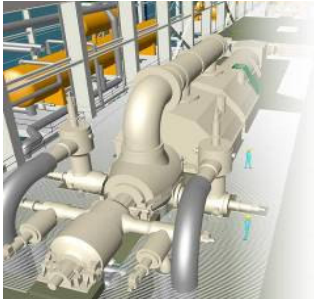

IMTE AG Power Consulting Engineers

www.imteag.com

600MW_{GROSS} 3-Casing (50Hz) USC Steam Turbine

Source: Siemens AG

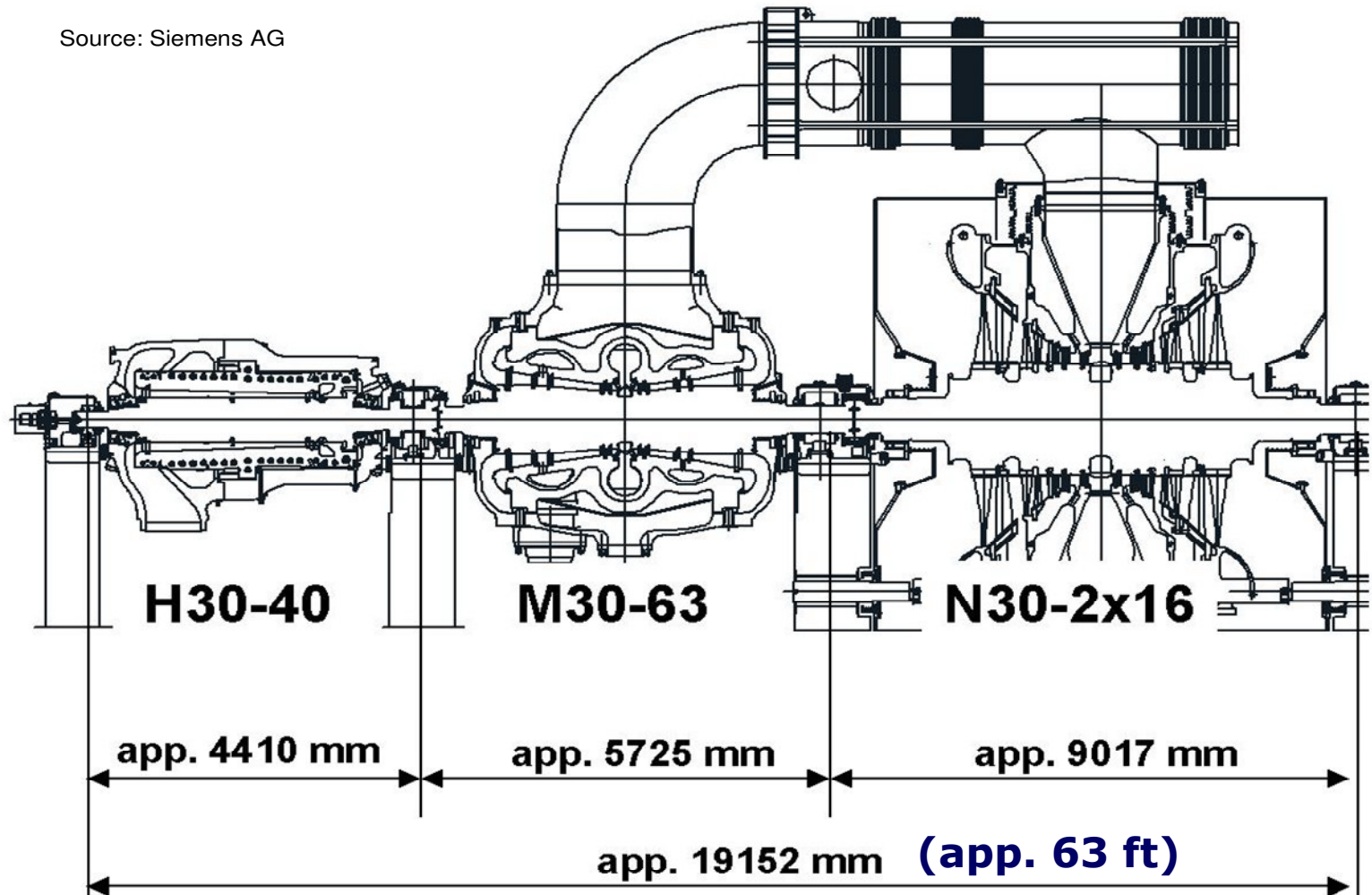

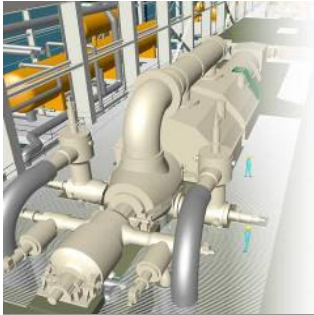

IMTE AG Power Consulting Engineers

www.imteag.com

50 Hz RPP – Water Steam Cycle Diagram

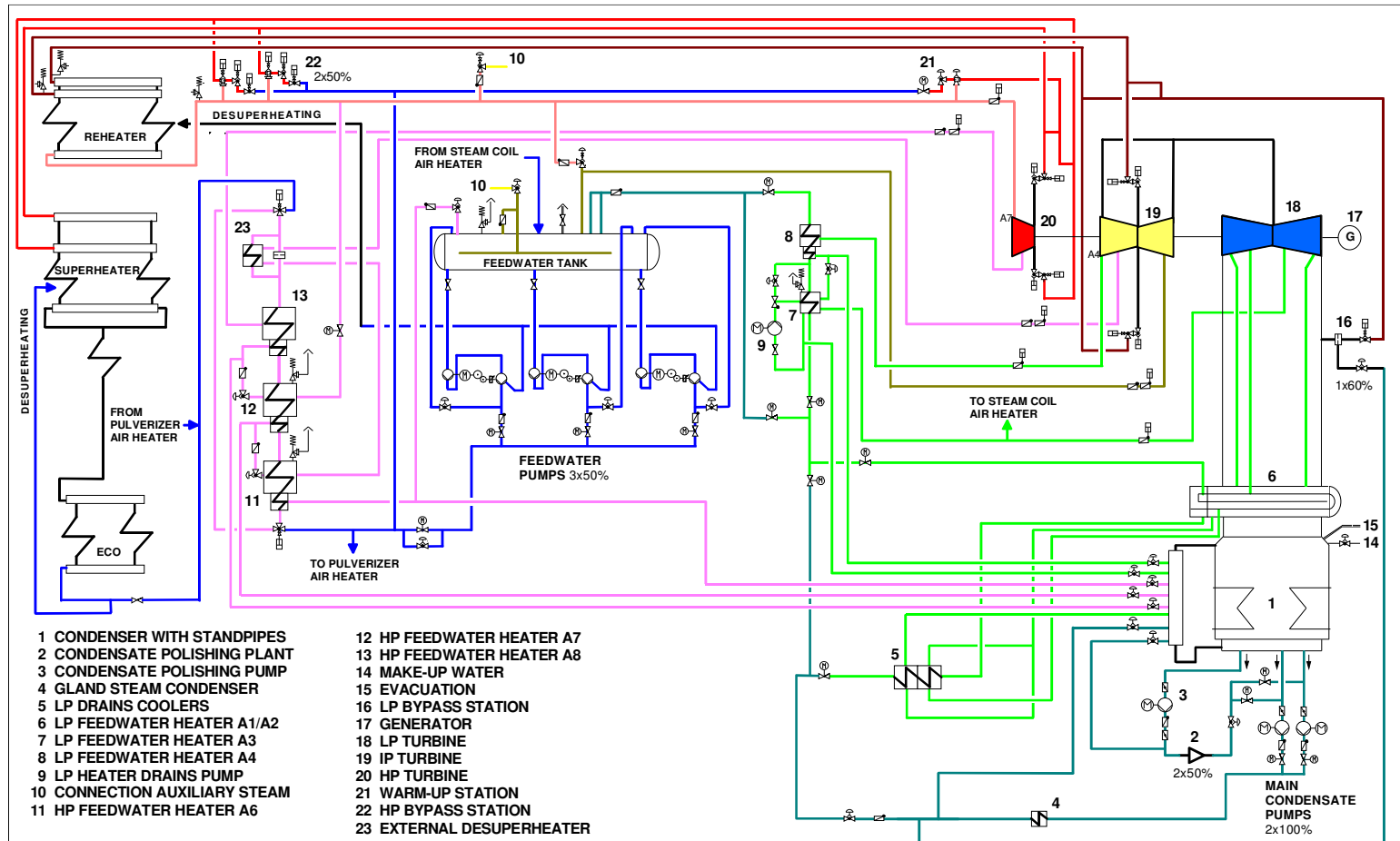

- 1 CONDENSER WITH STANDPIPES
- 2 CONDENSATE POLISHING PLANT
- 3 CONDENSATE POLISHING PUMP
- 4 GLAND STEAM CONDENSER
- 5 LP DRAINS COOLERS
- 6 LP FEEDWATER HEATER A1/A2
- 7 LP FEEDWATER HEATER A3
- 8 LP FEEDWATER HEATER A4
- 9 LP HEATER DRAINS PUMP
- 10 CONNECTION AUXILIARY STEAM
- 11 HP FEEDWATER HEATER A6
- 12 HP FEEDWATER HEATER A7
- 13 HP FEEDWATER HEATER A8
- 14 MAKE-UP WATER
- 15 EVACUATION
- 16 LP BYPASS STATION
- 17 GENERATOR
- 18 LP TURBINE
- 19 IP TURBINE
- 20 HP TURBINE
- 21 WARM-UP STATION
- 22 HP BYPASS STATION
- 23 EXTERNAL DESUPERHEATER

PKZ/PC ZDK006	Ua/Type of Des. XG02	Inhaltskennzeichen / Contents Code L	ZAI-No./Reg.No.
Discusst./Dept. W715	UND	Index Rev. -	Discusst./Dept. 2003-09-30
vgl. RWK NRW_basis_8_engl.dxf			

— Condensate Supply	— Feedwater Storage / Deaeration	— Main Steam Piping System	— Hot Reheat Piping System
— LP Feedwater Heating	— Feedwater Supply	— Cold Reheat Piping System	— Auxiliary Steam Piping System
— Feedwater Preheating			

RKW NRW
MODULES OF
WATER STEAM CYCLE
PREFERRED VARIANT
Siemens Power Generation PG

Coalgen 2006
© IMTE

NOT BINDING FOR EXECUTION

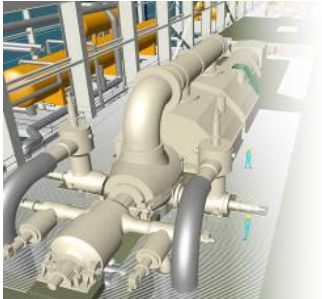

60Hz Varioplant – Main Parameters

- **Plant Gross Capacity** 800 MW
- **Plant Net Capacity** 725 MW
- **Live Steam Pressure** 28.5 MPa → 4134 psi
- **Live Steam Temperature** 600 °C → 1112 °F
- **Reheat Pressure** 6.0 MPa → 870 psi
- **Condenser Pressure** 4.5 kPa → 0.653 psi
- **Feed Water Temperature** 303 °C → 578 °F
- **Reheat Temperature** 610 °C → 1130 °F
- **Heat Rate_{NET/LHV}–Efficiency** 7435 Btu/kWh – 45.8 %
- **Boiler Type** OT-Benson
- **ST Type** 4 Casing – Single Reheat
1SF HP-1DF IP-2DF LP

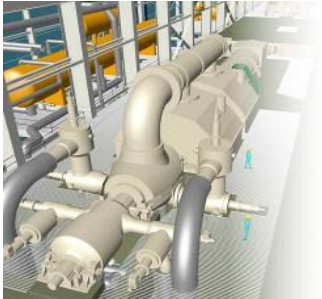

IMTE AG Power Consulting Engineers

www.imteag.com

800MW_{GROSS} 4-Casing (60Hz) USC Steam Turbine

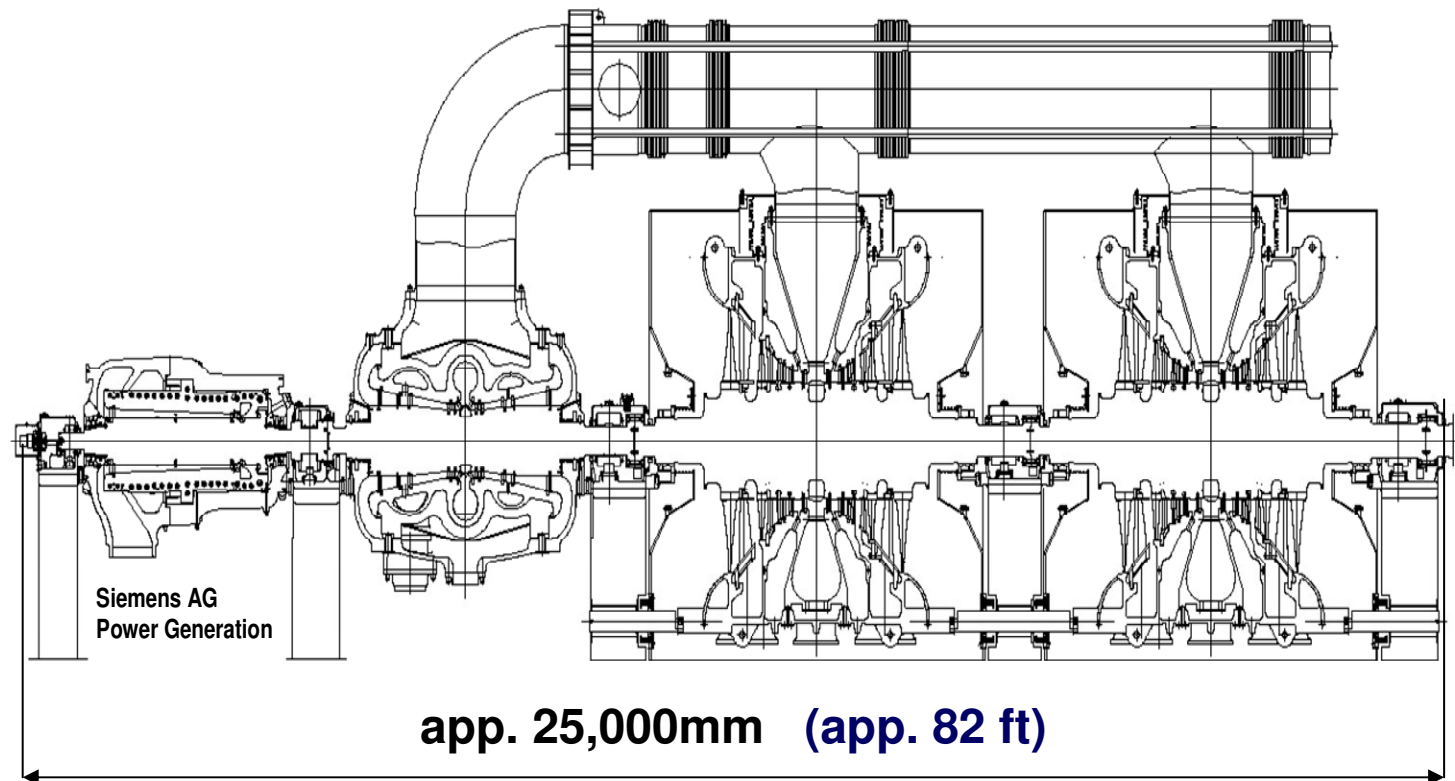

Coalgen 2006
© IMTE

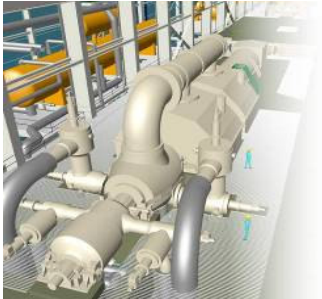

IMTE AG Power Consulting Engineers

www.imteag.com

60 Hz Varioplant – Water Steam Cycle Diagram

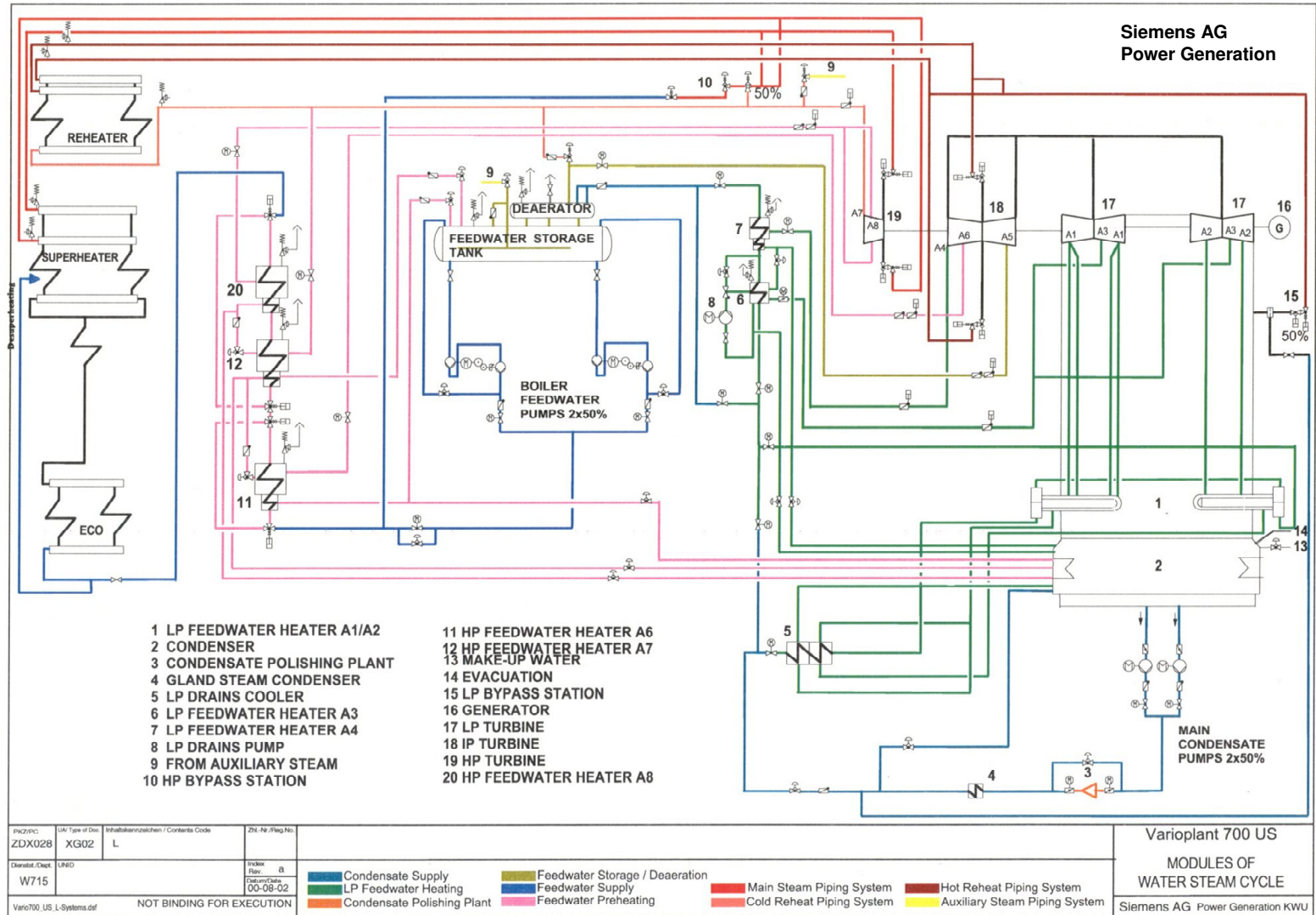

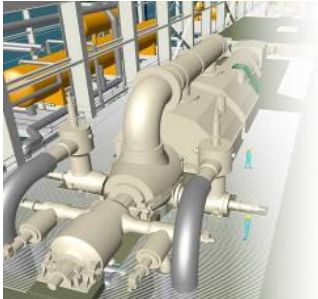

IMTE AG Power Consulting Engineers

www.imteag.com

60 Hz Varioplant – Water Steam Cycle Diagram

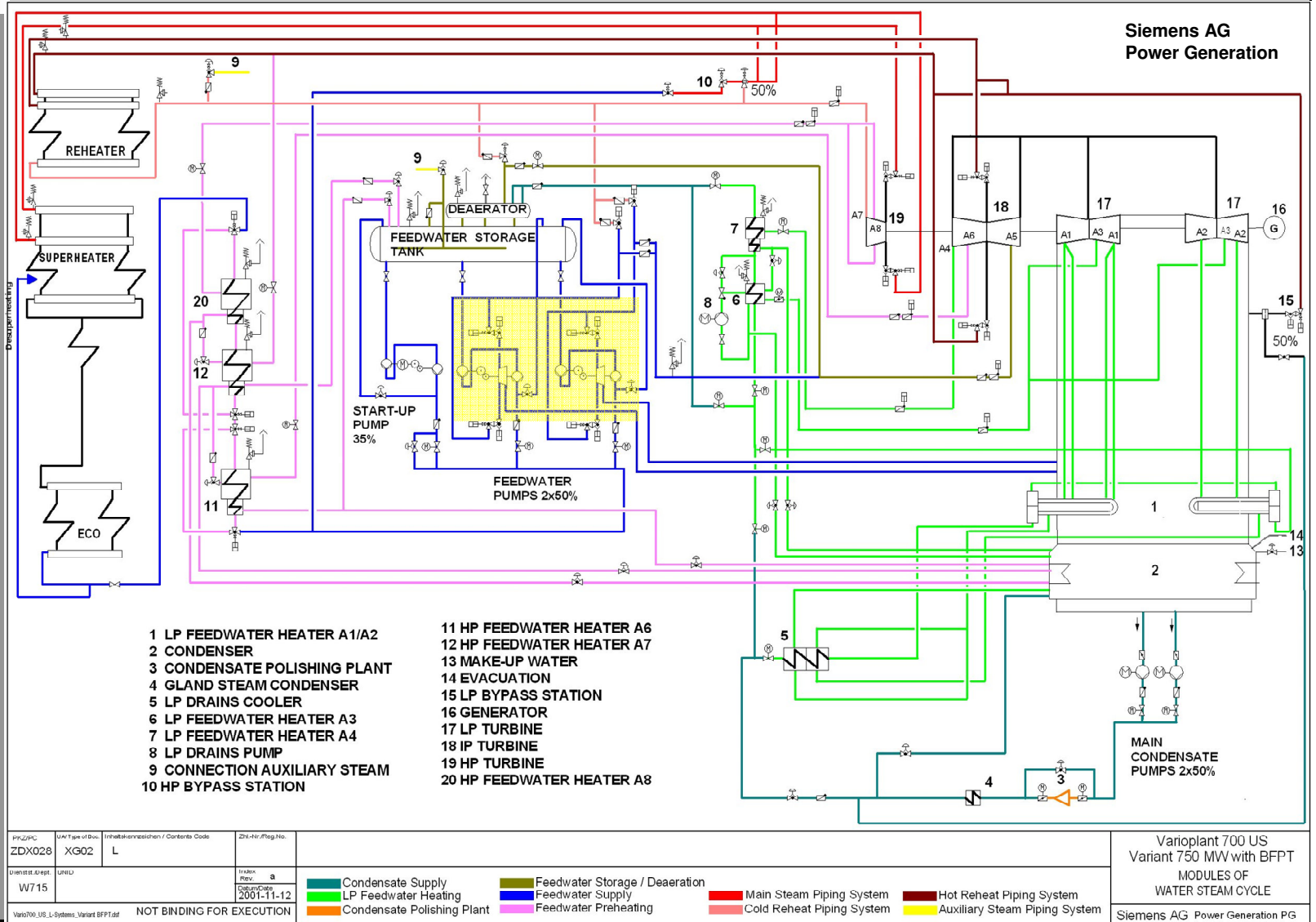

Coalgen 2006
© IMTE

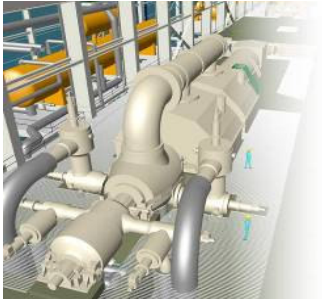

IMTE AG Power Consulting Engineers

www.imteag.com

Drum vs. OT Boiler

Drum Type Boiler

Operational Pressure

1.0 – 18.0 MPa

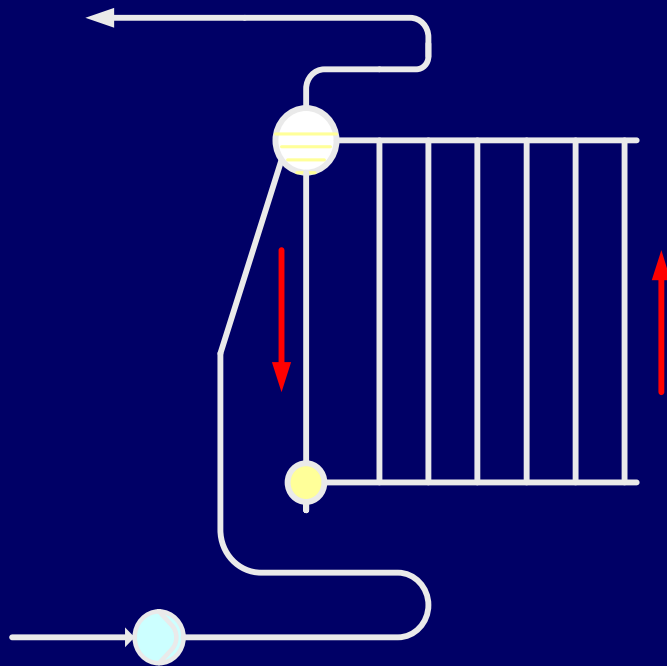

OT Type Boiler

Operational Pressure

2.0 – 40.0 MPa

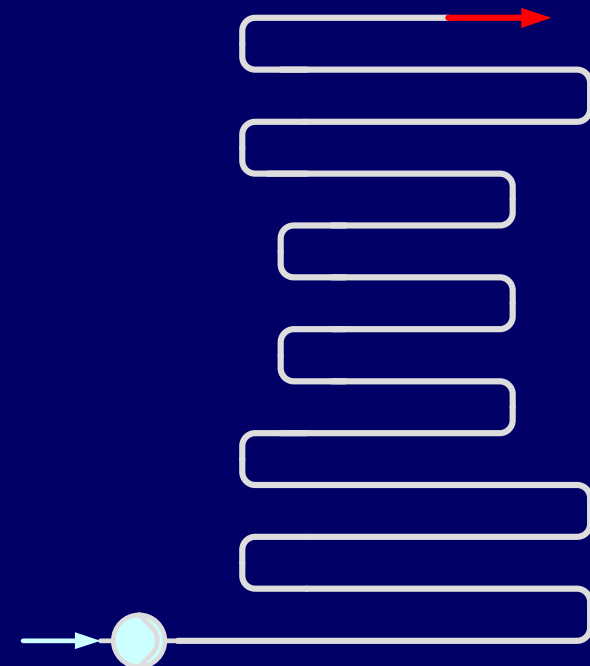

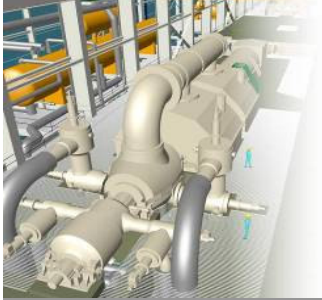

Drum vs. OT Boiler

Drum Boiler

- **Restricted to Sub-Critical Pressures**
- **Low Efficiency at Part Load**
- **Long Start-up Times**
- **Thick Walled Components (HP Drum) → Higher Thermal Stresses**
- **Feed Water Flow Control by Drum Water Level Control**
- **Lower Load Transients (4-5%)**

OT Boiler

- ❖ **Both Sub- & Super-Critical Pressures**
- ❖ **Highest Efficiency at Part & Full Load**
- ❖ **Short Start-up Times**
- ❖ **Thermoelastic Construction → Lower Thermal Stresses**
- ❖ **Feed Water Flow Control by after Evaporator Temperature / Enthalpy Control**
- ❖ **Higher Load Transients (6-8%)**

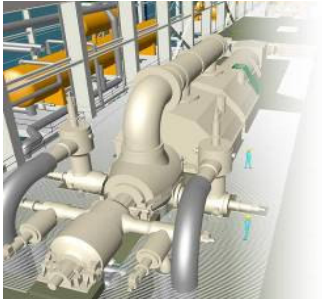

OT Boiler Furnace Arrangements

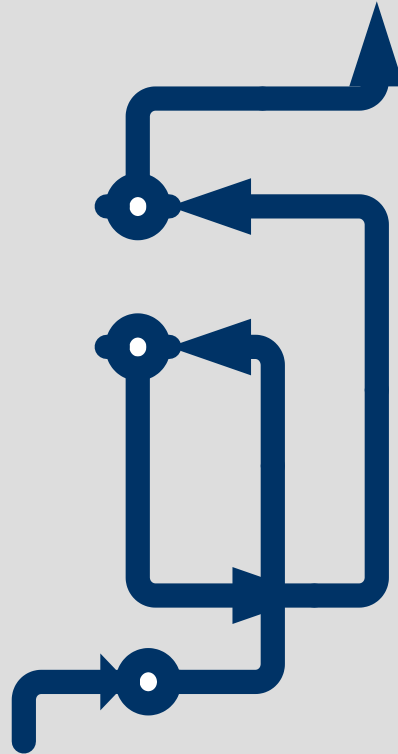

**Vertical Tube
Arrangement
High Mass Flux**

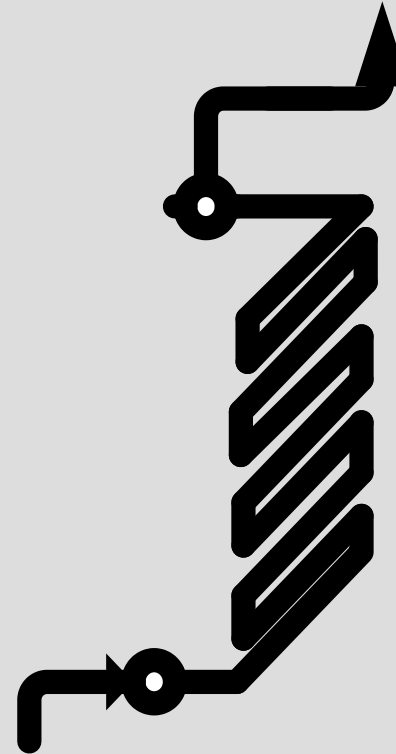

**Spiral Tube
Arrangement
High Mass Flux**

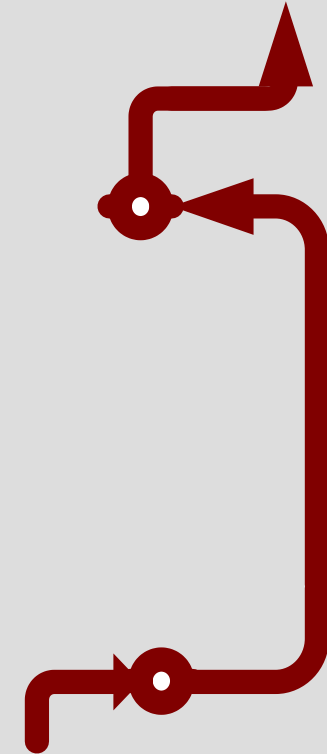

**Advanced Vertical
Tube Arrangement
Low Mass Flux**

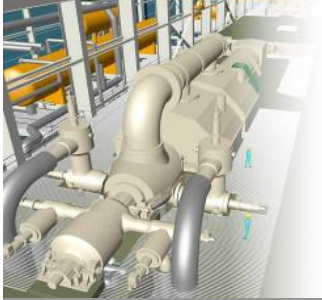

IMTE AG Power Consulting Engineers

www.imteag.com

Advantages of Vertical vs. Spiral Arrangement

- Cheaper Manufacture & Assembly
- Maintenance Friendly
- Part Load up to 20% at highest Main Steam Temperatures
- Reduced Slagging of Furnace Walls
- Lower Evaporator Pressure Loss
- Lower Auxiliary Power Requirement
- Simple Start-up System.

Coalgen 2006

© IMTE

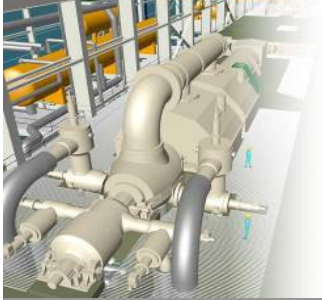

IMTE AG Power Consulting Engineers

www.imteag.com

Low Mass Flux Design (LMFD)

- Current OT boilers use Furnace Tube Mass Fluxes (FTMF) designs $>1,500-1,800\text{kg/m}^2\text{s}$
→ $1,106,190-1,327,430\text{lb/ft}^2\text{h}$
- FTMF levels below $1,000-1,200\text{kg/m}^2\text{s}$ → $737,460-884,950\text{lb/ft}^2\text{h}$ (LMFD) minimize the furnace dynamic pressure losses
- Thermo-hydraulic behavior of the LMFD becomes similar to natural circulation boilers.

Coalgen 2006

© IMTE

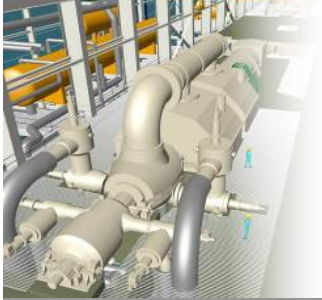

IMTE AG Power Consulting Engineers
www.imteag.com

Low Mass Flux Design (LMFD)

**Combination Vertical Tube Arrangement
with Low Mass Flux Design**



**Highly Efficient & Reliable Boiler with
Outstanding Operating Characteristics at
any Load from 20% part Load up to
Design Base Load.**

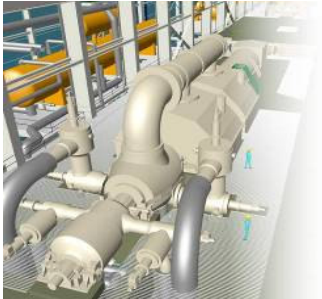

IMTE AG Power Consulting Engineers

www.imteag.com

OT Boiler Design Alternatives

Tower Boiler

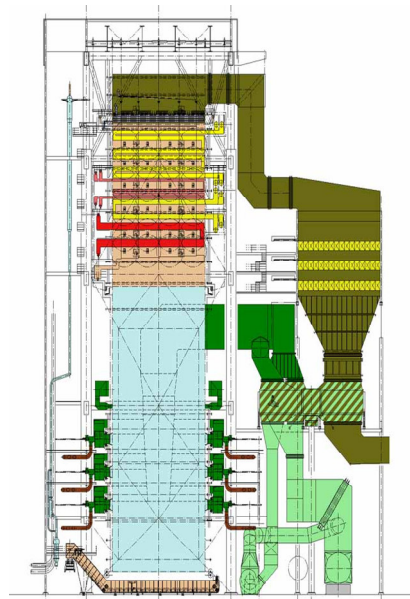

Floor space: 2,975 m²
Volume: 166,000 m³
Efficiency: 95%

Two-Pass Boiler

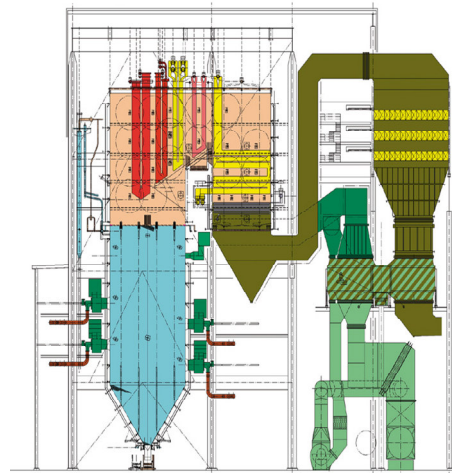

Floor space: 4,164 m²
Volume: 197,000 m³
Efficiency: 95%

Horizontal Boiler

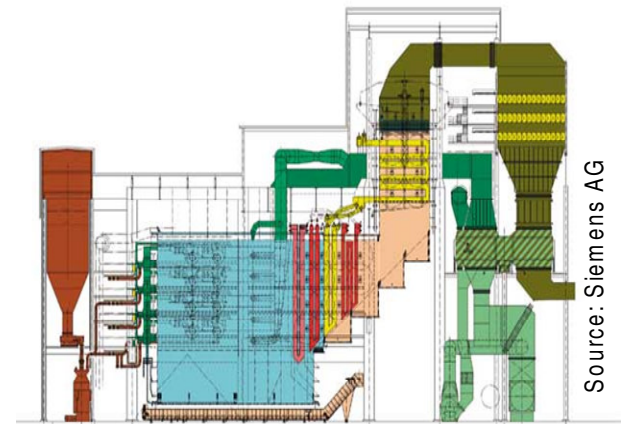

Floor space: 4,600 m²
Volume: 209,000 m³
Efficiency: 95%

Source: Siemens AG

Concept study reference power plant North Rhine-Westphalia (RPP NRW), Project 85.65.69 – T-138, VGB PowerTech e.V., 2004

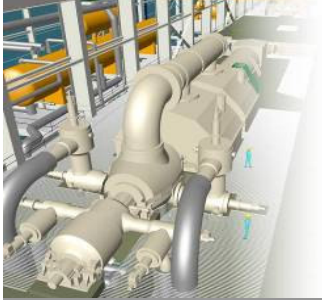

IMTE AG Power Consulting Engineers

www.imteag.com

OT Boiler Design Alternatives

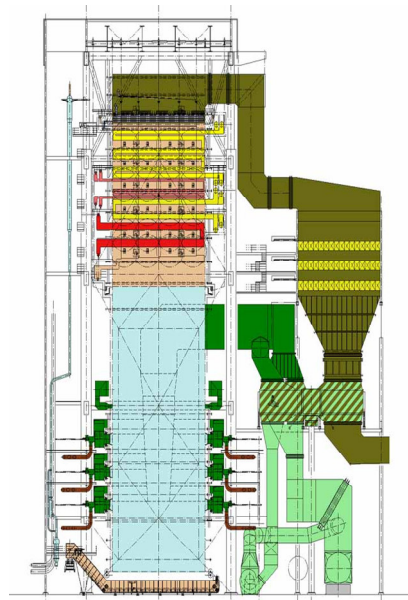

Floor space: 2,975 m²

Volume: 166,000 m³

Efficiency: 95%

Tower Boiler →

**Lowest Steel & Pressure Parts
& Floor Space Requirement.**

Allows Multilevel Coal Feeders.

High Hight.

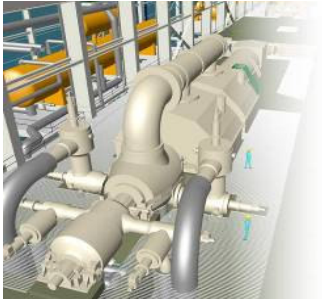

IMTE AG Power Consulting Engineers

www.imteag.com

OT Boiler Design Alternatives

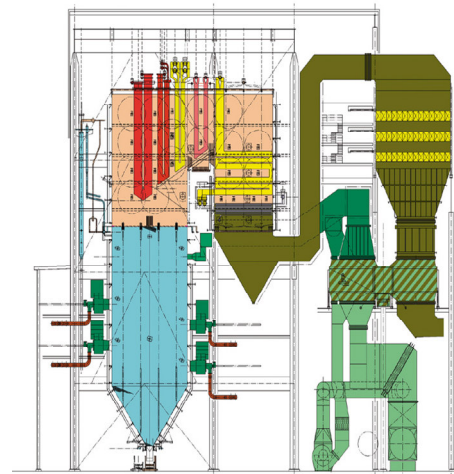

Floor space: 4,164 m²

Volume: 197,000 m³

Efficiency: 95%

Two-Pass Boiler →

High Steel, External Piping, Pressure Parts & Floor Space Requirement.

Short Assembly Time.

Low Height.

Coalgen 2006

© IMTE

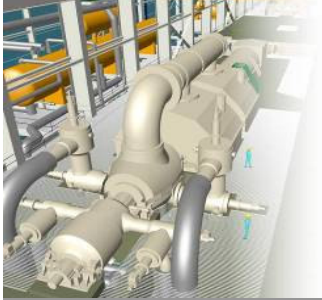

IMTE AG Power Consulting Engineers

www.imteag.com

OT Boiler Design Alternatives

Horizontal Boiler →

Lowest External Piping Requirement, High Steel & Floor Space Requirement.

Low Height.

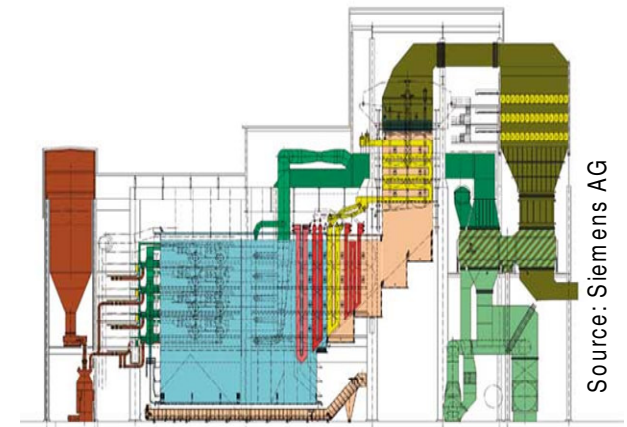

Source: Siemens AG

Floor space: 4,600 m²

Volume: 209,000 m³

Efficiency: 95%

Coalgen 2006

© IMTE

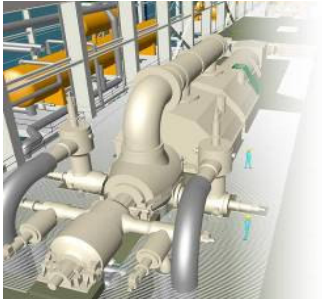

IMTE AG Power Consulting Engineers

www.imteag.com

Boiler Temperature & Material Development

Live Steam Pressure MPa (psi)	Live Steam Temperature °C (°F)	Date	Material	Equivalent to
<20.0 (<2900)	<520 (<968)	Since Early 60's	X 20	Cr Mo V 11 1
<25.0 (<3626)	<540 (<1004)	Since Early 80's	P 22	2 ¼ Cr Mo
<30.0 (<4351)	<560 (<1040)	Since Late 80's	P 91	9Cr – 1Mo
<33.0 (<4786)	<620 (<1148)	Since 2004	P 92	X10CrWMoVNb9-1 EUROPE STBA29-STPA29 JAPAN
<35.0 (<5076)	<700 (<1292)	Start 2010	Super Alloys	CCA 617 - IN 740 – Haynes 230 – Save 12

Coalgen 2006

© IMTE

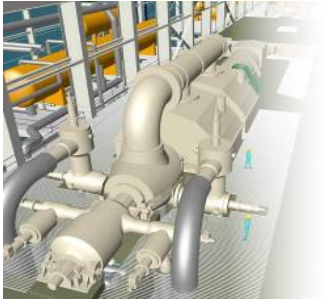

IMTE AG Power Consulting Engineers

www.imteag.com

ST Unit Size

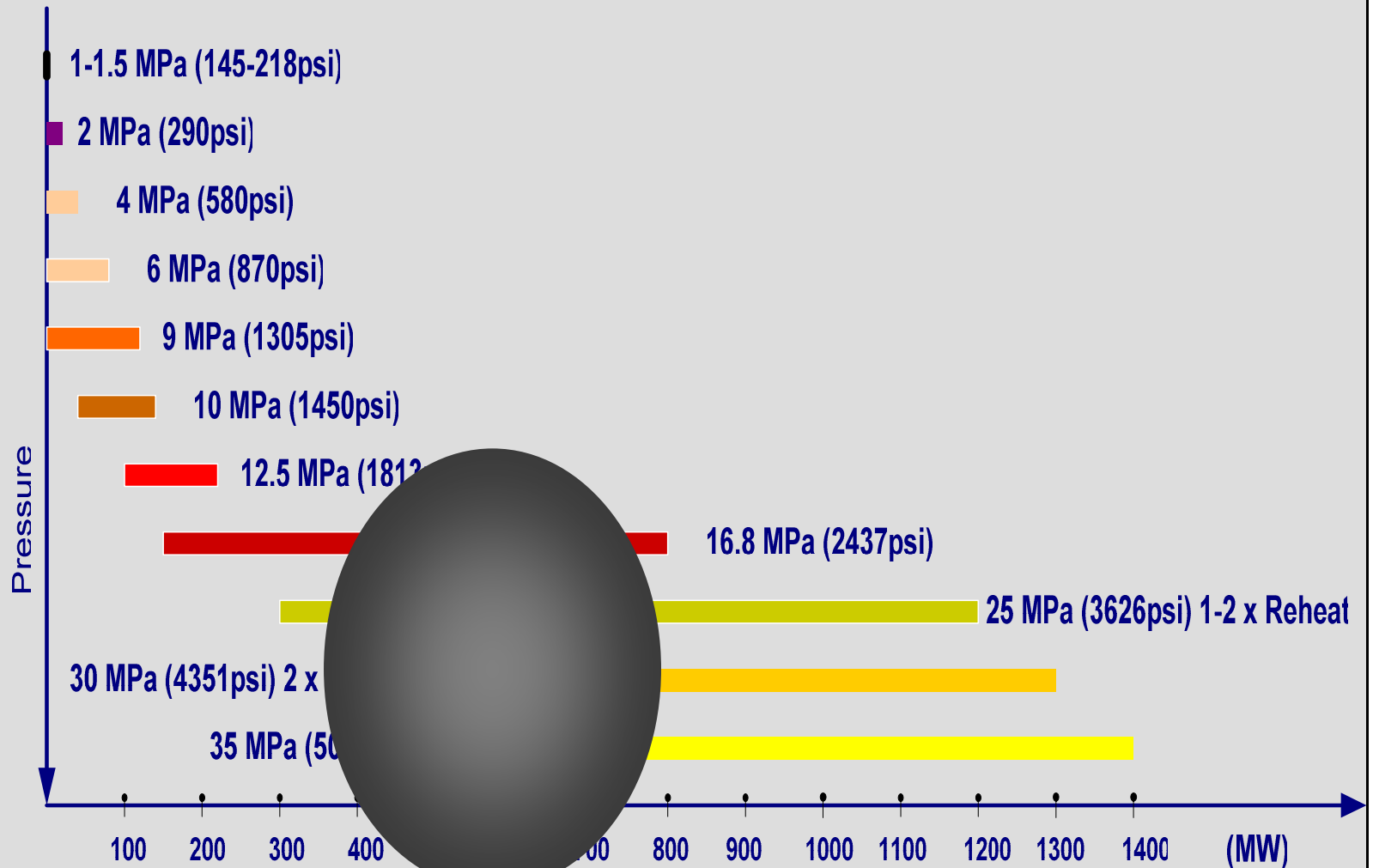

Coalgen 2006

© IMTE



IMTE AG Power Consulting Engineers

www.imteag.com

600MW_{GROSS} 3-Casing (50Hz) USC Steam Turbine

Source: Siemens AG

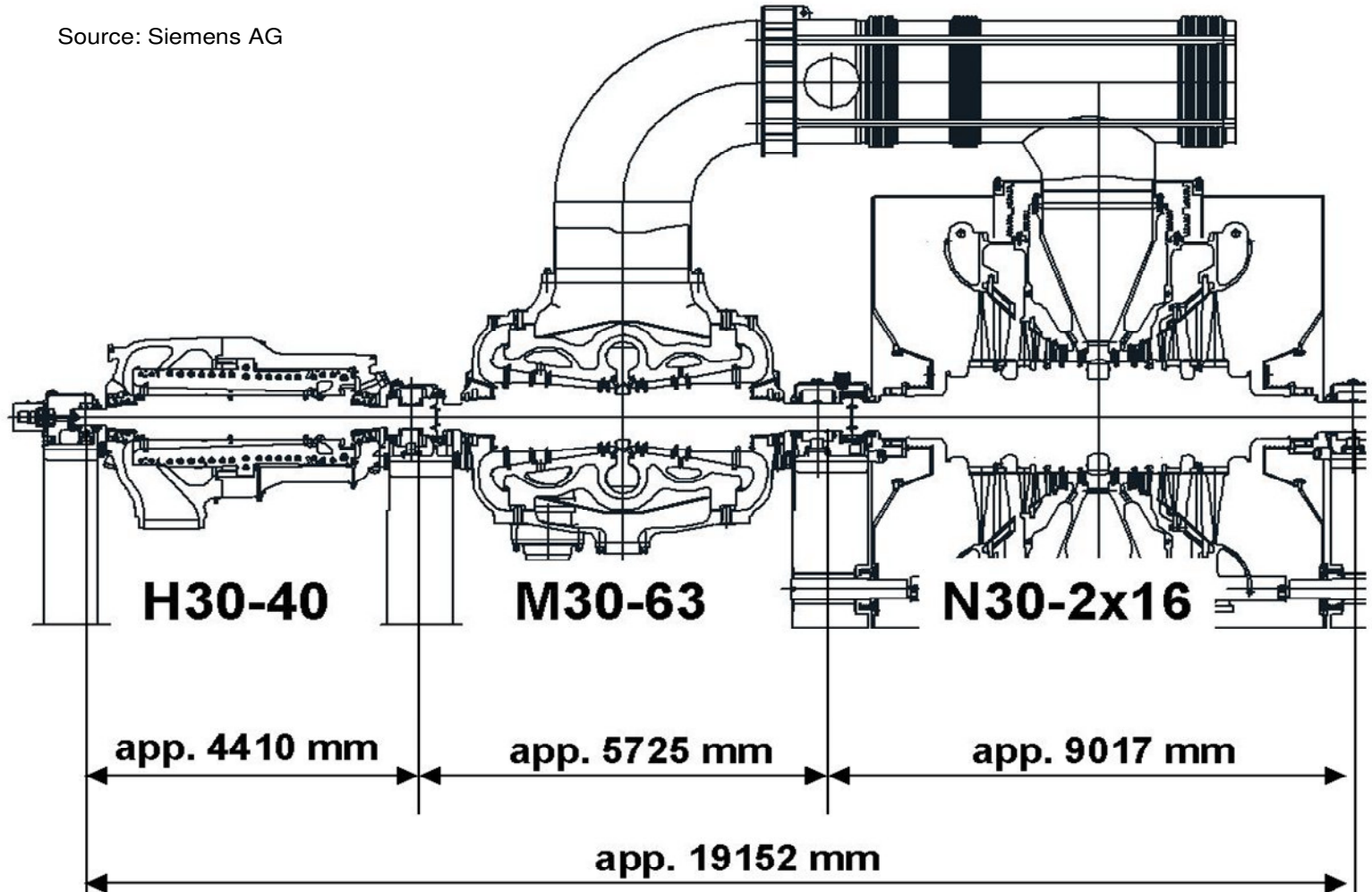

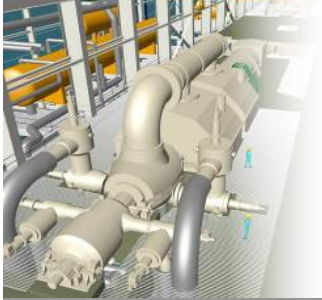

IMTE AG Power Consulting Engineers

www.imteag.com

Design Features (50Hz) 16m² Last Stage Blade

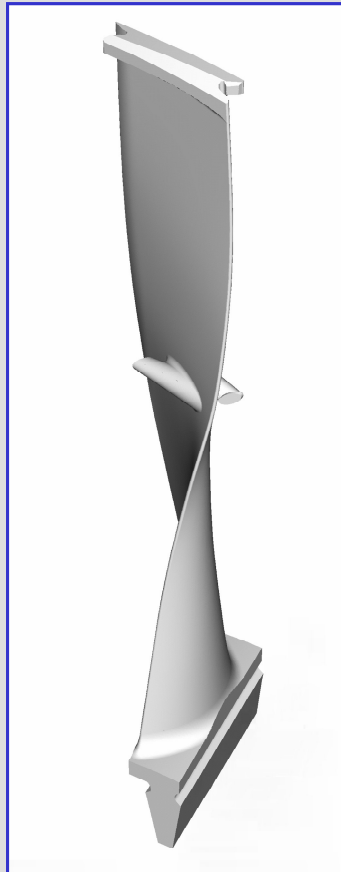

- **Rotor Diameter** 1,900 mm (74.8")
- **Blade Length** 1,400 mm (55.0")
- **Speed at Blade End** 738 m/s (1,435 knot)
- **Mach No at Blade End** 2.24
- **Blade Connection** Shroud & Snubber
- **Blade Material** Titanium

Source: Siemens AG

Coalgen 2006

© IMTE

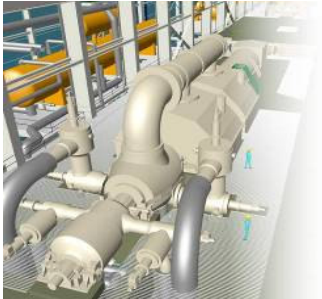

IMTE AG Power Consulting Engineers

www.imteag.com

ST Unit Size

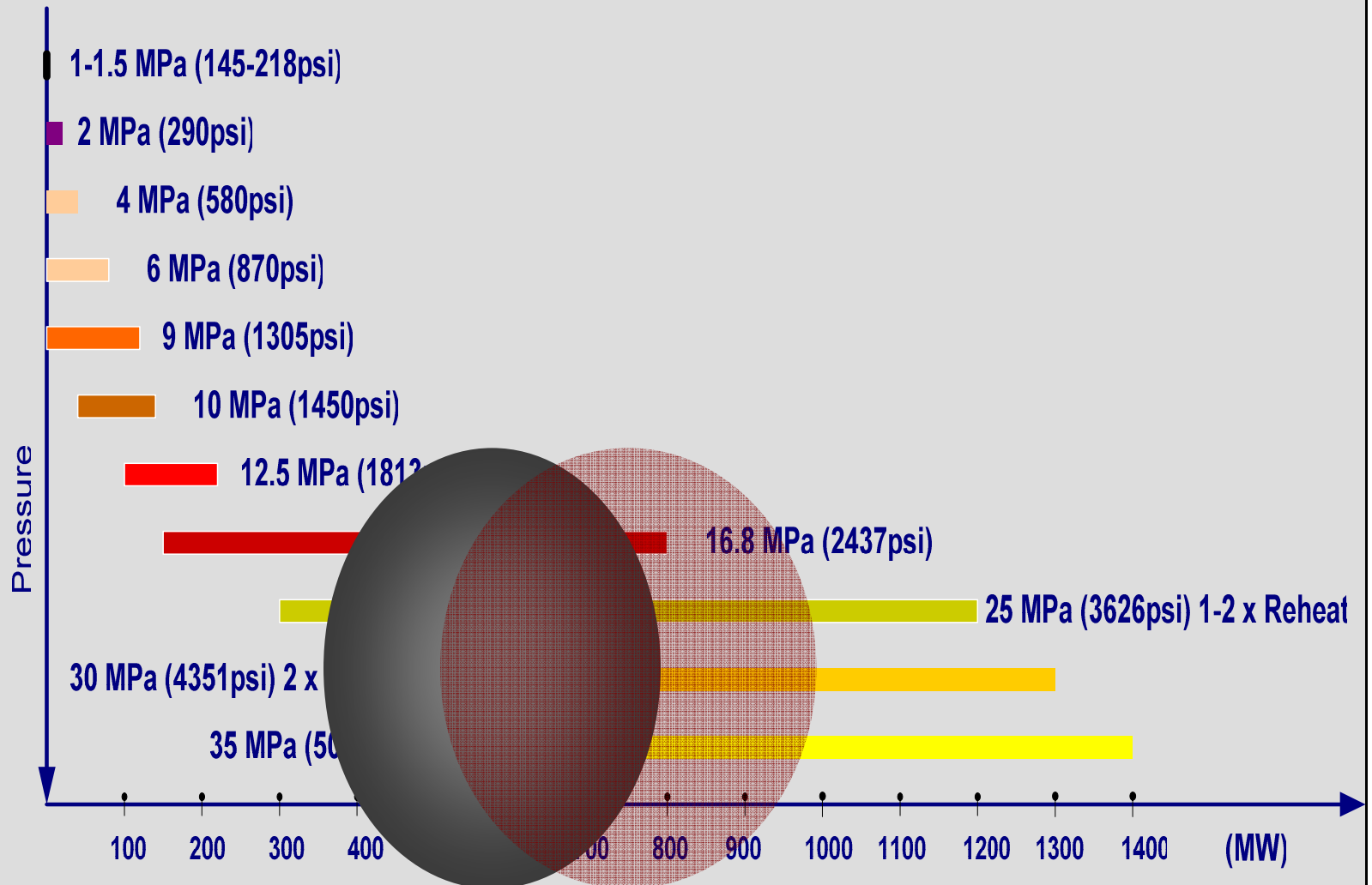

Coalgen 2006

© IMTE

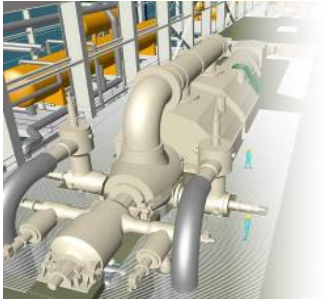

IMTE AG Power Consulting Engineers

www.imteag.com

ST Unit Size

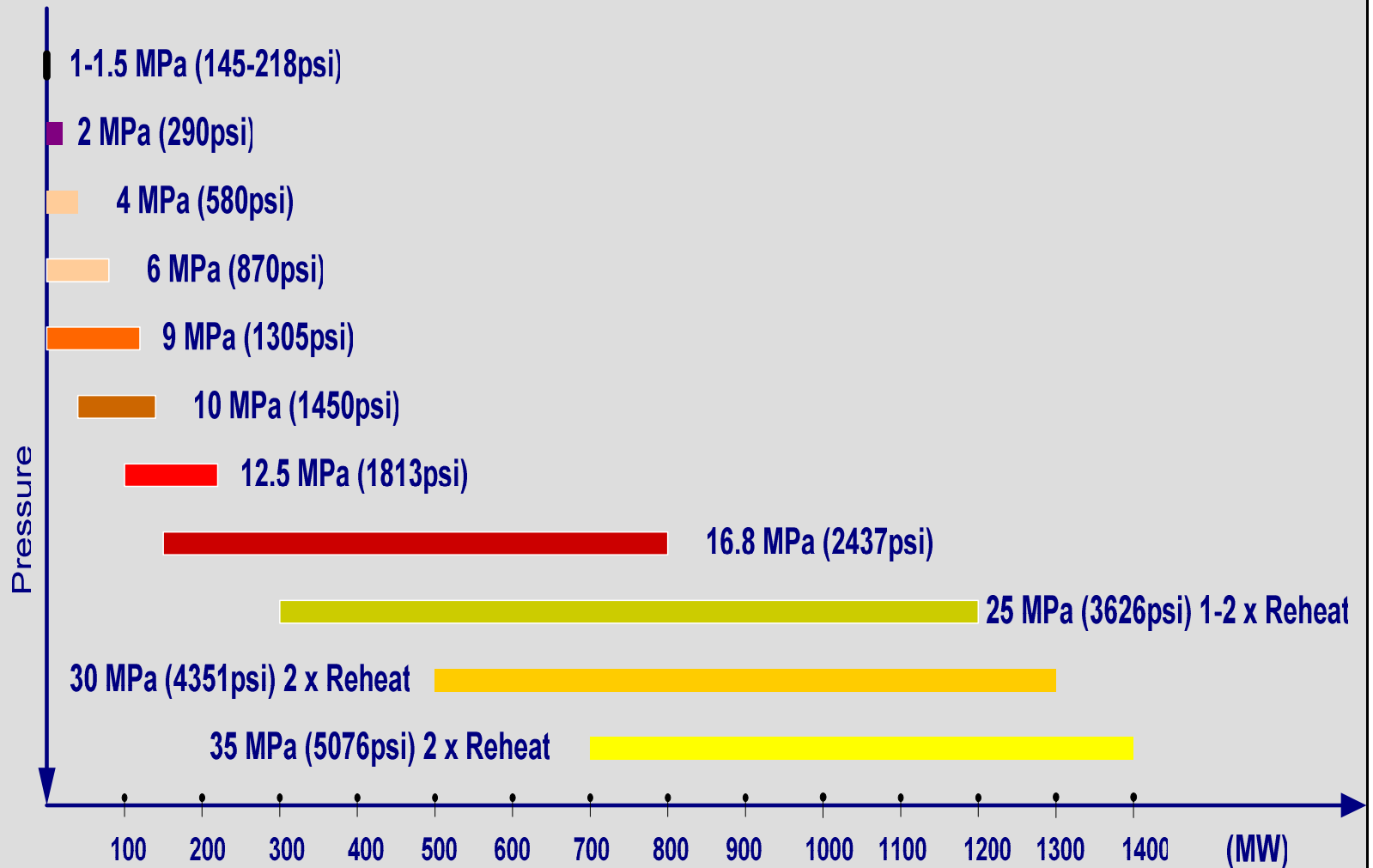

Coalgen 2006

© IMTE

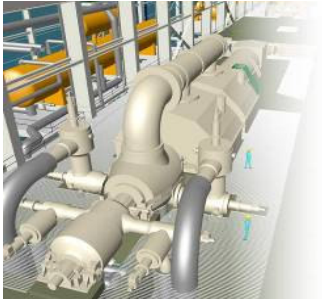

IMTE AG Power Consulting Engineers

www.imteag.com

800MW_{GROSS} 4-Casing (60Hz) USC Steam Turbine

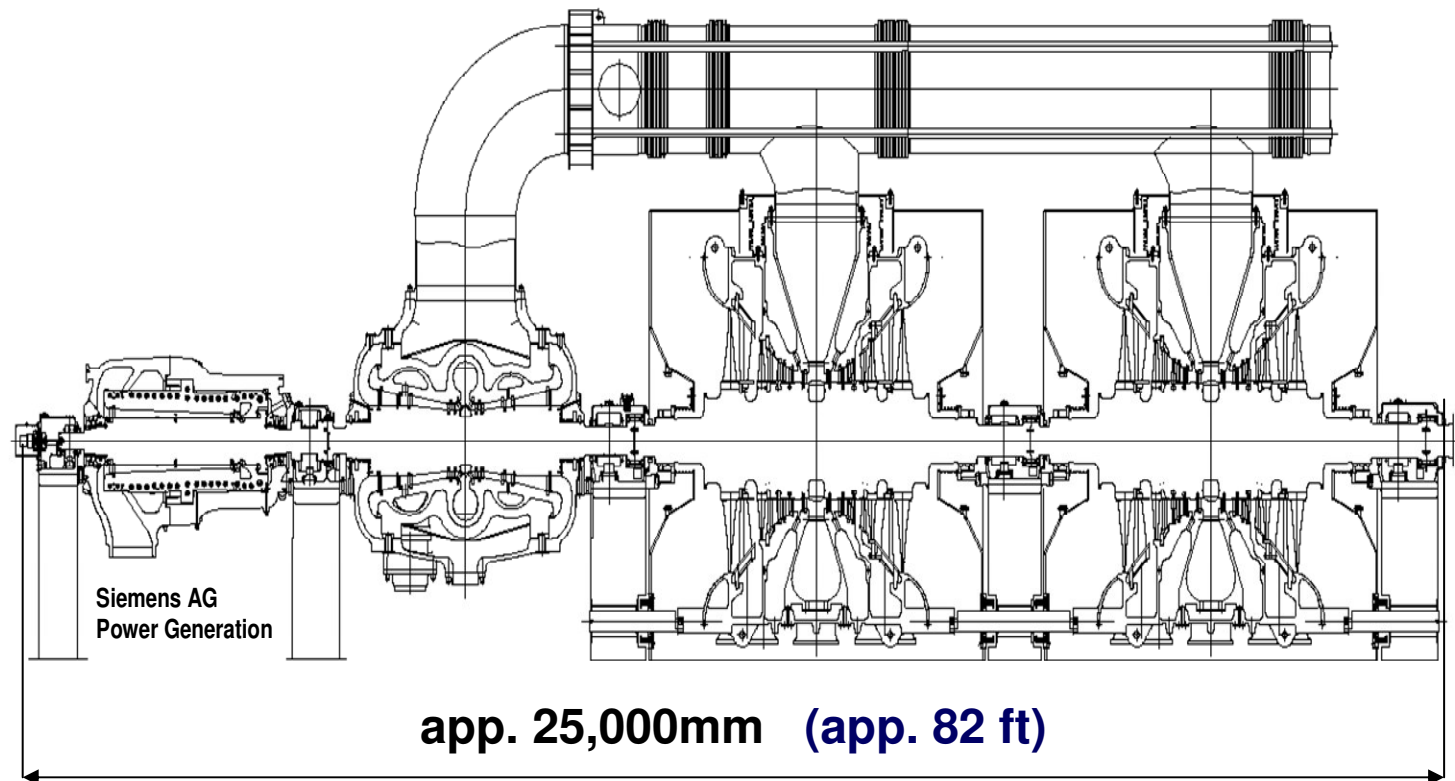

Coalgen 2006
© IMTE

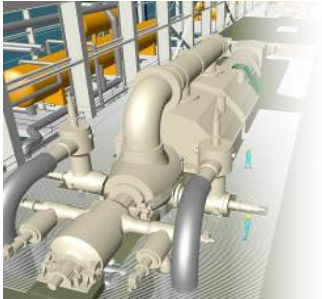

IMTE AG Power Consulting Engineers

www.imteag.com

Design Features (60Hz) 10.3 m² Last Stage Blade

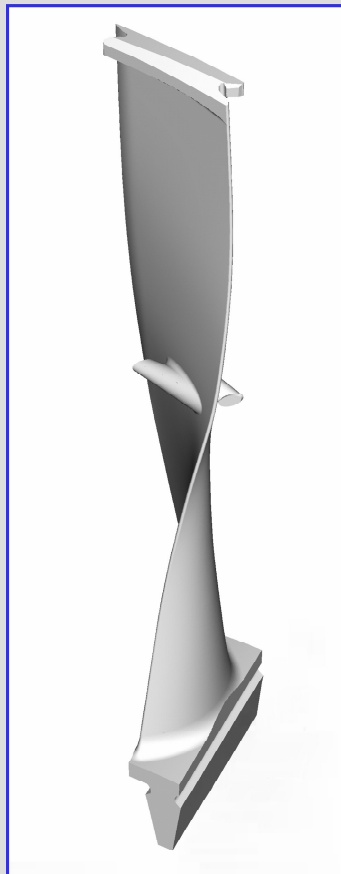

- **Rotor Diameter** 1,700 mm (67.0'')
- **Blade Length** 1,067 mm (42.0'')
- **Speed at Blade End** 722 m/s (1,403 knot)
- **Mach No at Blade End** 2.18
- **Blade Connection** Shroud & Snubber
- **Blade Material** Titanium

Source: Siemens AG

Coalgen 2006

© IMTE

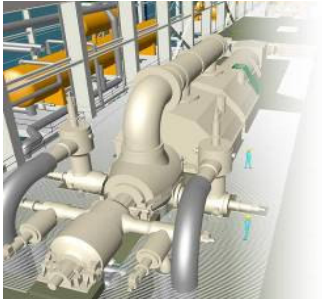

IMTE AG Power Consulting Engineers

www.imteag.com

60Hz SSP-600 ** 3-D Model of Turbine Island

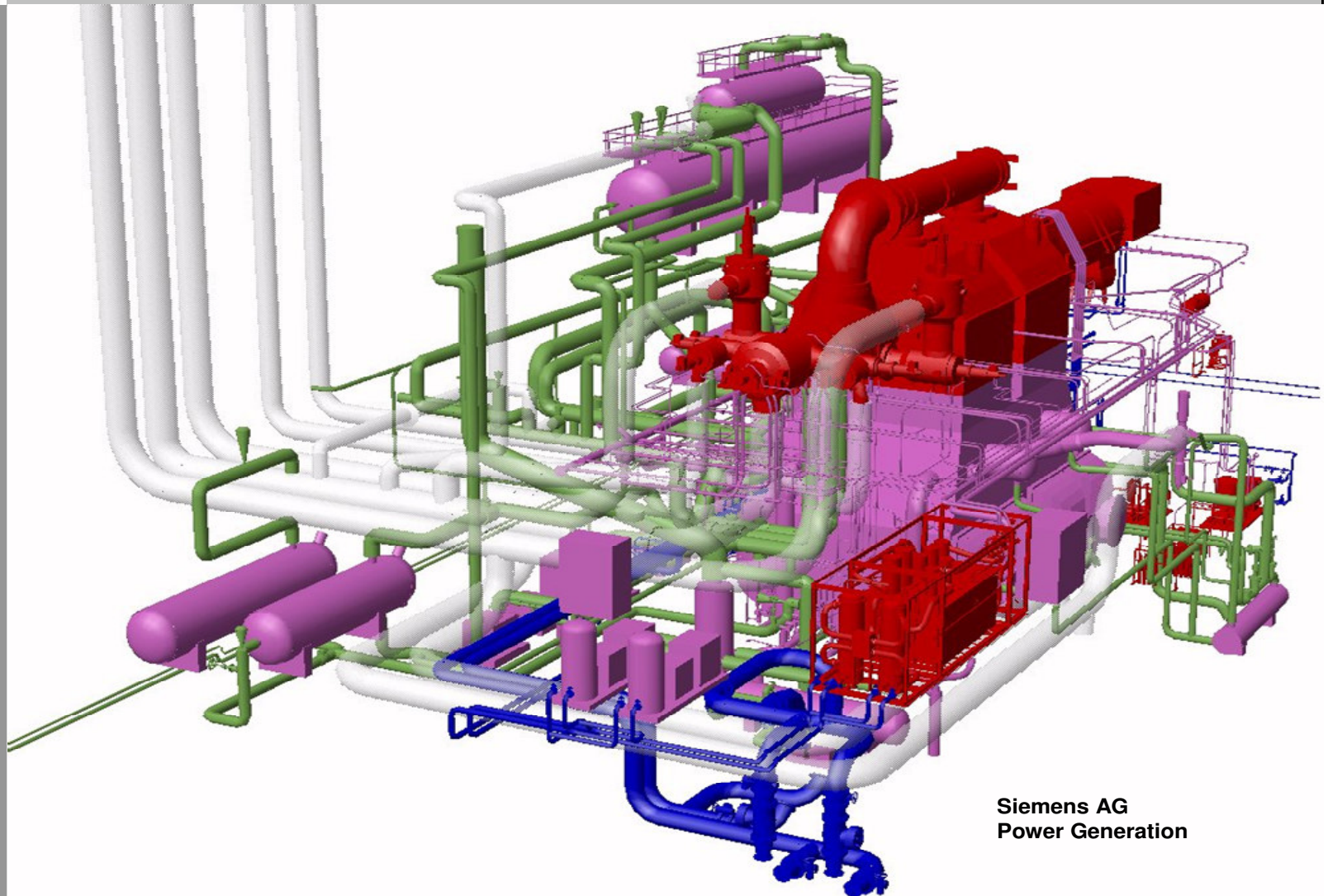

Coalgen 2006

© IMTE

Siemens AG
Power Generation

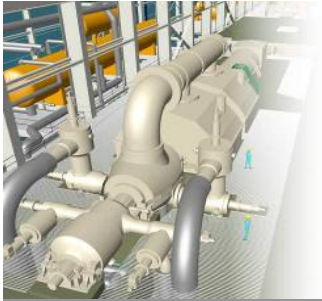

IMTE AG Power Consulting Engineers

www.imteag.com

ST Common Configurations

Double Shell * 1-Flow <50MW

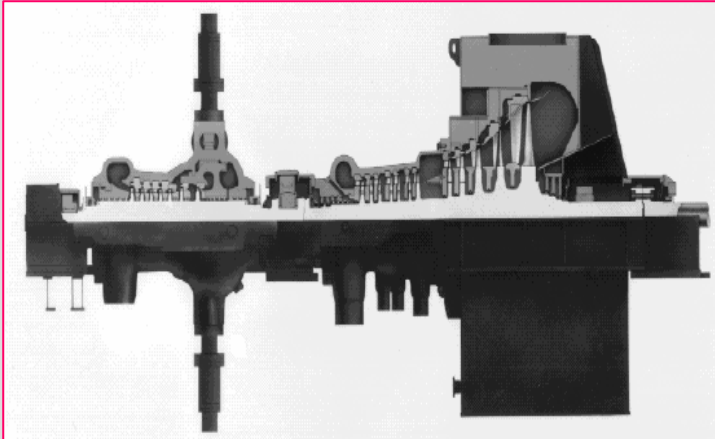

2-Casing * 2-Flow 300-600 MW

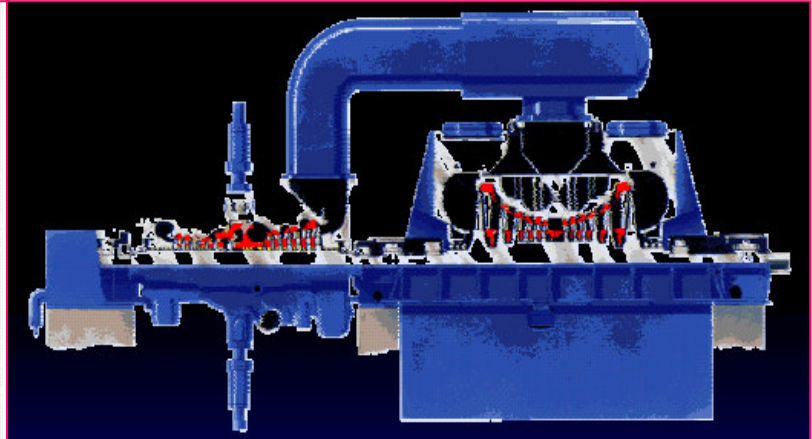

3-Casing * 4-Flow 400-700 MW

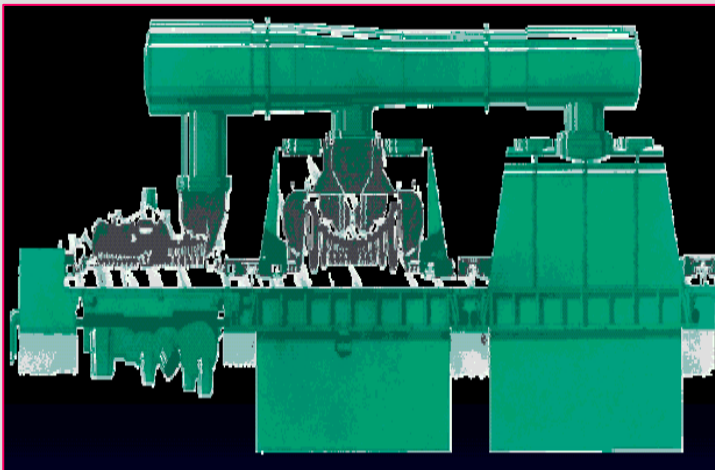

4-Casing * 4-Flow 700-1000 MW

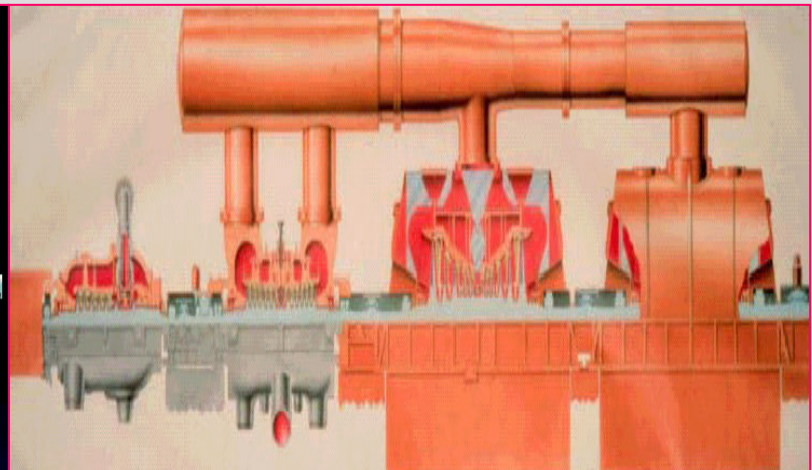

Coalgen 2006

© IMTE

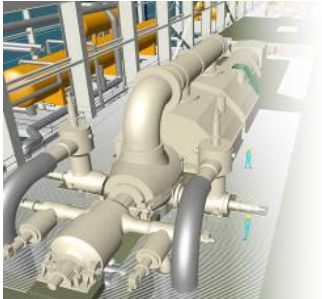

IMTE AG Power Consulting Engineers

www.imteag.com

ST Material Development (50Hz)

Steam Temperature	≤560 °C	≤620 °C	≤700 °C
Rotor	1Cr Mo V forging 12Cr Mo V Nb N 26Ni Cr Mo V11 5	9-12Cr W Co forging 12Cr Mo W V Nb N	IN 625 / IN 740 CCA 617 Haynes 230
Nozzles Valves	Cr Mo V Cast 10Cr Mo V Nb	9-10% Cr (W) Cast12Cr W (Co)	CCA 617 IN 625 / IN 714
Inner Casing Shells	1-2 Cr Mo Cast Cr Mo V Cast 9Cr 1 Mo V Nb (up to 590°C)	9-12% Cr (W) Cast12Cr W (Co)	CCA 617 IN 625 IN 740 (up to 760°C)
Blading	10Cr Mo V Nb N Titanium (last rotor row)	9-12% Cr W Co Titanium (last rotor row)	Wrought Ni-Base Titanium (last rotor row)
Bolting	9-12% Cr Mo V NI 80A; IN 718	9-12% Cr Mo VIN 718	Nimonic105 / 115 / 718 Allvac 718 Plus Waspaloy

Coalgen 2006

© IMTE

Pos	Power Plant Name	Country	Power Output MW _{GROSS}	Live Steam MPa /°C /°C (psi /°F /°F)	COD
01	Council Bluffs	USA (IA)	790	25.5 / 565 / 565 (3690/1050/1050)	2007
02	Weston 4	USA (WI)	500	36.2 / 580 / 580 (3800/1076/1076)	2007
03	Comanche 3	USA (CO)	750	26.2 / 570 / 570 (3800/1055/1055)	2009
04	Elm Road 1 & 2	USA (WI)	2 x 600	26.2 / 570 / 570 (3800/1055/1055)	2009
05	Iatan 2	USA (MO)	900	25.5 / 585 / 585 (3686/1085/1085)	2010
06	Genesee 3	Canada	495	25.0 / 570 / 568 (3626/1058/1054)	2005
07	RPP NRW _{60Hz}	USA	800	28.5 / 600 / 610 (4134/1112/1130)	2010
08	Lippendorf	Germany	934	26.7 / 554 / 583 (3873/1029/1081)	1999
09	Boxberg 1	Germany	907	26.6 / 545 / 581 (3860/1013/1078)	2000
10	Niederaussem	Germany	1027	27.5 / 580 / 600 (3989/1076/1112)	2003
11	RPP NRW _{50Hz}	Germany	600	28.5 / 600 / 620 (4134/1112/1148)	2008
12	Boa 2 Neurath	Germany	2 x 1100	26.0 / 595 / 595 (3771/1103/1103)	2010
13	Nordjylland 3	Denmark	411	29.0 / 582 / 580 (4206/1080/1076)	1998
14	Avedoere 2	Denmark	450	30.0 / 580 / 600 (4351/1076/1112)	2002
15	Schwarze Pumpe	Germany	2 x 800	26.8 / 547 / 565 (3742/1017/1078)	1996
16	Tachibana-Wan	Japan	1050	25.9 / 600 / 610 (3756/1112/1130)	2000
17	Hitachi-Naka 1	Japan	1000	25.4 / 604 / 602 (3684/1119/1116)	2003
18	Isogo 1	Japan	600	28.0 / 605 / 613 (4061/1121/1135)	2002
19	Misumi	Japan	1000	25.0 / 600 / 605 (3626/1112/1121)	1998
20	Wangqu	PR China	2 x 600	27.5 / 571 / 569 (3989/1060/1056)	2007
21	Waigaoqiao	PR China	2 x 900	27.9 / 542 / 562 (4047/1008/1044)	2004
22	Zouxian IV	PR China	2 x 1000	27.0 / 600 / 600 (3916/1112/1112)	2008
23	Huaneng	PR China	4 x 1000	26.5 / 600 / 600 (3844/1112/1112)	2008
24	Cogan Creek	Australia	700	26.0 / 540 / 560 (3626/1004/1040)	2008

Pos	Power Plant Name	Country	Power Output MW _{GROSS}	Live Steam MPa /°C /°C (psi /°F /°F)	COD
01	Council Bluffs	USA (IA)	790	25.5 / 565 / 565 (3690/1050/1050)	2007
02	Weston 4	USA (WI)	500	36.2 / 580 / 580 (3800/1076/1076)	2007
03	Comanche 3	USA (CO)	750	26.2 / 570 / 570 (3800/1055/1055)	2009
04	Elm Road 1 & 2	USA (WI)	2 x 600	26.2 / 570 / 570 (3800/1055/1055)	2009
05	Iatan 2	USA (MO)	900	25.5 / 585 / 585 (3686/1085/1085)	2010
06	Genesee 3	Canada	495	25.0 / 570 / 568 (3626/1058/1054)	2005
07	RPP NRW _{60Hz}	USA	800	28.5 / 600 / 610 (4134/1112/1130)	2010
08	Lippendorf	Germany	934	26.7 / 554 / 583 (3873/1029/1081)	1999
09	Boxberg 1	Germany	907	26.6 / 545 / 581 (3860/1013/1078)	2000
10	Niederaussem	Germany	1027	27.5 / 580 / 600 (3989/1076/1112)	2003
11	RPP NRW _{50Hz}	Germany	600	28.5 / 600 / 620 (4134/1112/1148)	2008
12	Boa 2 Neurath	Germany	2 x 1100	26.0 / 595 / 595 (3771/1103/1103)	2010
13	Nordjylland 3	Denmark	411	29.0 / 582 / 580 (4206/1080/1076)	1998
14	Avedoere 2	Denmark	450	30.0 / 580 / 600 (4351/1076/1112)	2002
15	Schwarze Pumpe	Germany	2 x 800	26.8 / 547 / 565 (3742/1017/1078)	1996
16	Tachibana-Wan	Japan	1050	25.9 / 600 / 610 (3756/1112/1130)	2000
17	Hitachi-Naka 1	Japan	1000	25.4 / 604 / 602 (3684/1119/1116)	2003
18	Isogo 1	Japan	600	28.0 / 605 / 613 (4061/1121/1135)	2002
19	Misumi	Japan	1000	25.0 / 600 / 605 (3626/1112/1121)	1998
20	Wangqu	PR China	2 x 600	27.5 / 571 / 569 (3989/1060/1056)	2007
21	Waigaoqiao	PR China	2 x 900	27.9 / 542 / 562 (4047/1008/1044)	2004
22	Zouxian IV	PR China	2 x 1000	27.0 / 600 / 600 (3916/1112/1112)	2008
23	Huaneng	PR China	4 x 1000	26.5 / 600 / 600 (3844/1112/1112)	2008
24	Cogan Creek	Australia	700	26.0 / 540 / 560 (3626/1004/1040)	2008

Pos	Power Plant Name	Country	Power Output MW _{GROSS}	Live Steam MPa /°C /°C (psi /°F /°F)	COD
01	Council Bluffs	USA (IA)	790	25.5 / 565 / 565 (3690/1050/1050)	2007
02	Weston 4	USA (WI)	500	36.2 / 580 / 580 (3800/1076/1076)	2007
03	Comanche 3	USA (CO)	750	26.2 / 570 / 570 (3800/1055/1055)	2009
04	Elm Road 1 & 2	USA (WI)	2 x 600	26.2 / 570 / 570 (3800/1055/1055)	2009
05	Iatan 2	USA (MO)	900	25.5 / 585 / 585 (3686/1085/1085)	2010
06	Genesee 3	Canada	495	25.0 / 570 / 568 (3626/1058/1054)	2005
07	RPP NRW _{60Hz}	USA	800	28.5 / 600 / 610 (4134/1112/1130)	2010
08	Lippendorf	Germany	934	26.7 / 554 / 583 (3873/1029/1081)	1999
09	Boxberg 1	Germany	907	26.6 / 545 / 581 (3860/1013/1078)	2000
10	Niederaussem	Germany	1027	27.5 / 580 / 600 (3989/1076/1112)	2003
11	RPP NRW _{50Hz}	Germany	600	28.5 / 600 / 620 (4134/1112/1148)	2008
12	Boa 2 Neurath	Germany	2 x 1100	26.0 / 595 / 595 (3771/1103/1103)	2010
13	Nordjylland 3	Denmark	411	29.0 / 582 / 580 (4206/1080/1076)	1998
14	Avedoere 2	Denmark	450	30.0 / 580 / 600 (4351/1076/1112)	2002
15	Schwarze Pumpe	Germany	2 x 800	26.8 / 547 / 565 (3742/1017/1078)	1996
16	Tachibana-Wan	Japan	1050	25.9 / 600 / 610 (3756/1112/1130)	2000
17	Hitachi-Naka 1	Japan	1000	25.4 / 604 / 602 (3684/1119/1116)	2003
18	Isogo 1	Japan	600	28.0 / 605 / 613 (4061/1121/1135)	2002
19	Misumi	Japan	1000	25.0 / 600 / 605 (3626/1112/1121)	1998
20	Wangqu	PR China	2 x 600	27.5 / 571 / 569 (3989/1060/1056)	2007
21	Waigaoqiao	PR China	2 x 900	27.9 / 542 / 562 (4047/1008/1044)	2004
22	Zouxian IV	PR China	2 x 1000	27.0 / 600 / 600 (3916/1112/1112)	2008
23	Huaneng	PR China	4 x 1000	26.5 / 600 / 600 (3844/1112/1112)	2008
24	Cogan Creek	Australia	700	26.0 / 540 / 560 (3626/1004/1040)	2008

Pos	Power Plant Name	Country	Power Output MW _{GROSS}	Live Steam MPa /°C /°C (psi /°F /°F)	COD
01	Council Bluffs	USA (IA)	790	25.5 / 565 / 565 (3690/1050/1050)	2007
02	Weston 4	USA (WI)	500	36.2 / 580 / 580 (3800/1076/1076)	2007
03	Comanche 3	USA (CO)	750	26.2 / 570 / 570 (3800/1055/1055)	2009
04	Elm Road 1 & 2	USA (WI)	2 x 600	26.2 / 570 / 570 (3800/1055/1055)	2009
05	Iatan 2	USA (MO)	900	25.5 / 585 / 585 (3686/1085/1085)	2010
06	Genesee 3	Canada	495	25.0 / 570 / 568 (3626/1058/1054)	2005
07	RPP NRW _{60Hz}	USA	800	28.5 / 600 / 610 (4134/1112/1130)	2010
08	Lippendorf	Germany	934	26.7 / 554 / 583 (3873/1029/1081)	1999
09	Boxberg 1	Germany	907	26.6 / 545 / 581 (3860/1013/1078)	2000
10	Niederaussem	Germany	1027	27.5 / 580 / 600 (3989/1076/1112)	2003
11	RPP NRW _{50Hz}	Germany	600	28.5 / 600 / 620 (4134/1112/1148)	2008
12	Boa 2 Neurath	Germany	2 x 1100	26.0 / 595 / 595 (3771/1103/1103)	2010
13	Nordjylland 3	Denmark	411	29.0 / 582 / 580 (4206/1080/1076)	1998
14	Avedoere 2	Denmark	450	30.0 / 580 / 600 (4351/1076/1112)	2002
15	Schwarze Pumpe	Germany	2 x 800	26.8 / 547 / 565 (3742/1017/1078)	1996
16	Tachibana-Wan	Japan	1050	25.9 / 600 / 610 (3756/1112/1130)	2000
17	Hitachi-Naka 1	Japan	1000	25.4 / 604 / 602 (3684/1119/1116)	2003
18	Isogo 1	Japan	600	28.0 / 605 / 613 (4061/1121/1135)	2002
19	Misumi	Japan	1000	25.0 / 600 / 605 (3626/1112/1121)	1998
20	Wangqu	PR China	2 x 600	27.5 / 571 / 569 (3989/1060/1056)	2007
21	Waigaoqiao	PR China	2 x 900	27.9 / 542 / 562 (4047/1008/1044)	2004
22	Zouxian IV	PR China	2 x 1000	27.0 / 600 / 600 (3916/1112/1112)	2008
23	Huaneng	PR China	4 x 1000	26.5 / 600 / 600 (3844/1112/1112)	2008
24	Cogan Creek	Australia	700	26.0 / 540 / 560 (3626/1004/1040)	2008

Pos	Power Plant Name	Country	Power Output MW _{GROSS}	Live Steam MPa /°C /°C (psi /°F /°F)	COD
01	Council Bluffs	USA (IA)	790	25.5 / 565 / 565 (3690/1050/1050)	2007
02	Weston 4	USA (WI)	500	36.2 / 580 / 580 (3800/1076/1076)	2007
03	Comanche 3	USA (CO)	750	26.2 / 570 / 570 (3800/1055/1055)	2009
04	Elm Road 1 & 2	USA (WI)	2 x 600	26.2 / 570 / 570 (3800/1055/1055)	2009
05	Iatan 2	USA (MO)	900	25.5 / 585 / 585 (3686/1085/1085)	2010
06	Genesee 3	Canada	495	25.0 / 570 / 568 (3626/1058/1054)	2005
07	RPP NRW _{60Hz}	USA	800	28.5 / 600 / 610 (4134/1112/1130)	2010
08	Lippendorf	Germany	934	26.7 / 554 / 583 (3873/1029/1081)	1999
09	Boxberg 1	Germany	907	26.6 / 545 / 581 (3860/1013/1078)	2000
10	Niederaussem	Germany	1027	27.5 / 580 / 600 (3989/1076/1112)	2003
11	RPP NRW _{50Hz}	Germany	600	28.5 / 600 / 620 (4134/1112/1148)	2008
12	Boa 2 Neurath	Germany	2 x 1100	26.0 / 595 / 595 (3771/1103/1103)	2010
13	Nordjylland 3	Denmark	411	29.0 / 582 / 580 (4206/1080/1076)	1998
14	Avedoere 2	Denmark	450	30.0 / 580 / 600 (4351/1076/1112)	2002
15	Schwarze Pumpe	Germany	2 x 800	26.8 / 547 / 565 (3742/1017/1078)	1996
16	Tachibana-Wan	Japan	1050	25.9 / 600 / 610 (3756/1112/1130)	2000
17	Hitachi-Naka 1	Japan	1000	25.4 / 604 / 602 (3684/1119/1116)	2003
18	Isogo 1	Japan	600	28.0 / 605 / 613 (4061/1121/1135)	2002
19	Misumi	Japan	1000	25.0 / 600 / 605 (3626/1112/1121)	1998
20	Wangqu	PR China	2 x 600	27.5 / 571 / 569 (3989/1060/1056)	2007
21	Waigaoqiao	PR China	2 x 900	27.9 / 542 / 562 (4047/1008/1044)	2004
22	Zouxian IV	PR China	2 x 1000	27.0 / 600 / 600 (3916/1112/1112)	2008
23	Huaneng	PR China	4 x 1000	26.5 / 600 / 600 (3844/1112/1112)	2008
24	Cogan Creek	Australia	700	26.0 / 540 / 560 (3626/1004/1040)	2008

Pos	Power Plant Name	Country	Power Output MW _{GROSS}	Live Steam MPa /°C /°C (psi /°F /°F)	COD
01	Council Bluffs	USA (IA)	790	25.5 / 565 / 565 (3690/1050/1050)	2007
02	Weston 4	USA (WI)	500	36.2 / 580 / 580 (3800/1076/1076)	2007
03	Comanche 3	USA (CO)	750	26.2 / 570 / 570 (3800/1055/1055)	2009
04	Elm Road 1 & 2	USA (WI)	2 x 600	26.2 / 570 / 570 (3800/1055/1055)	2009
05	Iatan 2	USA (MO)	900	25.5 / 585 / 585 (3686/1085/1085)	2010
06	Genesee 3	Canada	495	25.0 / 570 / 568 (3626/1058/1054)	2005
07	RPP NRW _{60Hz}	USA	800	28.5 / 600 / 610 (4134/1112/1130)	2010
08	Lippendorf	Germany	934	26.7 / 554 / 583 (3873/1029/1081)	1999
09	Boxberg 1	Germany	907	26.6 / 545 / 581 (3860/1013/1078)	2000
10	Niederaussem	Germany	1027	27.5 / 580 / 600 (3989/1076/1112)	2003
11	RPP NRW _{50Hz}	Germany	600	28.5 / 600 / 620 (4134/1112/1148)	2008
12	Boa 2 Neurath	Germany	2 x 1100	26.0 / 595 / 595 (3771/1103/1103)	2010
13	Nordjylland 3	Denmark	411	29.0 / 582 / 580 (4206/1080/1076)	1998
14	Avedoere 2	Denmark	450	30.0 / 580 / 600 (4351/1076/1112)	2002
15	Schwarze Pumpe	Germany	2 x 800	26.8 / 547 / 565 (3742/1017/1078)	1996
16	Tachibana-Wan	Japan	1050	25.9 / 600 / 610 (3756/1112/1130)	2000
17	Hitachi-Naka 1	Japan	1000	25.4 / 604 / 602 (3684/1119/1116)	2003
18	Isogo 1	Japan	600	28.0 / 605 / 613 (4061/1121/1135)	2002
19	Misumi	Japan	1000	25.0 / 600 / 605 (3626/1112/1121)	1998
20	Wangqu	PR China	2 x 600	27.5 / 571 / 569 (3989/1060/1056)	2007
21	Waigaoqiao	PR China	2 x 900	27.9 / 542 / 562 (4047/1008/1044)	2004
22	Zouxian IV	PR China	2 x 1000	27.0 / 600 / 600 (3916/1112/1112)	2008
23	Huaneng	PR China	4 x 1000	26.5 / 600 / 600 (3844/1112/1112)	2008
24	Cogan Creek	Australia	700	26.0 / 540 / 560 (3626/1004/1040)	2008

Pos	Power Plant Name	Country	Power Output MW _{GROSS}	Live Steam MPa /°C /°C (psi /°F /°F)	COD
01	Council Bluffs	USA (IA)	790	25.5 / 565 / 565 (3690/1050/1050)	2007
02	Weston 4	USA (WI)	500	36.2 / 580 / 580 (3800/1076/1076)	2007
03	Comanche 3	USA (CO)	750	26.2 / 570 / 570 (3800/1055/1055)	2009
04	Elm Road 1 & 2	USA (WI)	2 x 600	26.2 / 570 / 570 (3800/1055/1055)	2009
05	Iatan 2	USA (MO)	900	25.5 / 585 / 585 (3686/1085/1085)	2010
06	Genesee 3	Canada	495	25.0 / 570 / 568 (3626/1058/1054)	2005
07	RPP NRW _{60Hz}	USA	800	28.5 / 600 / 610 (4134/1112/1130)	2010
08	Lippendorf	Germany	934	26.7 / 554 / 583 (3873/1029/1081)	1999
09	Boxberg 1	Germany	907	26.6 / 545 / 581 (3860/1013/1078)	2000
10	Niederaussem	Germany	1027	27.5 / 580 / 600 (3989/1076/1112)	2003
11	RPP NRW _{50Hz}	Germany	600	28.5 / 600 / 620 (4134/1112/1148)	2008
12	Boa 2 Neurath	Germany	2 x 1100	26.0 / 595 / 595 (3771/1103/1103)	2010
13	Nordjylland 3	Denmark	411	29.0 / 582 / 580 (4206/1080/1076)	1998
14	Avedoere 2	Denmark	450	30.0 / 580 / 600 (4351/1076/1112)	2002
15	Schwarze Pumpe	Germany	2 x 800	26.8 / 547 / 565 (3742/1017/1078)	1996
16	Tachibana-Wan	Japan	1050	25.9 / 600 / 610 (3756/1112/1130)	2000
17	Hitachi-Naka 1	Japan	1000	25.4 / 604 / 602 (3684/1119/1116)	2003
18	Isogo 1	Japan	600	28.0 / 605 / 613 (4061/1121/1135)	2002
19	Misumi	Japan	1000	25.0 / 600 / 605 (3626/1112/1121)	1998
20	Wangqu	PR China	2 x 600	27.5 / 571 / 569 (3989/1060/1056)	2007
21	Waigaoqiao	PR China	2 x 900	27.9 / 542 / 562 (4047/1008/1044)	2004
22	Zouxian IV	PR China	2 x 1000	27.0 / 600 / 600 (3916/1112/1112)	2008
23	Huaneng	PR China	4 x 1000	26.5 / 600 / 600 (3844/1112/1112)	2008
24	Cogan Creek	Australia	700	26.0 / 540 / 560 (3626/1004/1040)	2008

Pos	Power Plant Name	Country	Power Output MW _{GROSS}	Live Steam MPa /°C /°C (psi /°F /°F)	COD
01	Council Bluffs	USA (IA)	790	25.5 / 565 / 565 (3690/1050/1050)	2007
02	Weston 4	USA (WI)	500	36.2 / 580 / 580 (3800/1076/1076)	2007
03	Comanche 3	USA (CO)	750	26.2 / 570 / 570 (3800/1055/1055)	2009
04	Elm Road 1 & 2	USA (WI)	2 x 600	26.2 / 570 / 570 (3800/1055/1055)	2009
05	Iatan 2	USA (MO)	900	25.5 / 585 / 585 (3686/1085/1085)	2010
06	Genesee 3	Canada	495	25.0 / 570 / 568 (3626/1058/1054)	2005
07	RPP NRW _{60Hz}	USA	800	28.5 / 600 / 610 (4134/1112/1130)	2010
08	Lippendorf	Germany	934	26.7 / 554 / 583 (3873/1029/1081)	1999
09	Boxberg 1	Germany	907	26.6 / 545 / 581 (3860/1013/1078)	2000
10	Niederaussem	Germany	1027	27.5 / 580 / 600 (3989/1076/1112)	2003
11	RPP NRW _{50Hz}	Germany	600	28.5 / 600 / 620 (4134/1112/1148)	2008
12	Boa 2 Neurath	Germany	2 x 1100	26.0 / 595 / 595 (3771/1103/1103)	2010
13	Nordjylland 3	Denmark	411	29.0 / 582 / 580 (4206/1080/1076)	1998
14	Avedoere 2	Denmark	450	30.0 / 580 / 600 (4351/1076/1112)	2002
15	Schwarze Pumpe	Germany	2 x 800	26.8 / 547 / 565 (3742/1017/1078)	1996
16	Tachibana-Wan	Japan	1050	25.9 / 600 / 610 (3756/1112/1130)	2000
17	Hitachi-Naka 1	Japan	1000	25.4 / 604 / 602 (3684/1119/1116)	2003
18	Isogo 1	Japan	600	28.0 / 605 / 613 (4061/1121/1135)	2002
19	Misumi	Japan	1000	25.0 / 600 / 605 (3626/1112/1121)	1998
20	Wangqu	PR China	2 x 600	27.5 / 571 / 569 (3989/1060/1056)	2007
21	Waigaoqiao	PR China	2 x 900	27.9 / 542 / 562 (4047/1008/1044)	2004
22	Zouxian IV	PR China	2 x 1000	27.0 / 600 / 600 (3916/1112/1112)	2008
23	Huaneng	PR China	4 x 1000	26.5 / 600 / 600 (3844/1112/1112)	2008
24	Cogan Creek	Australia	700	26.0 / 540 / 560 (3626/1004/1040)	2008

Pos	Power Plant Name	Country	Power Output MW _{GROSS}	Live Steam MPa /°C /°C (psi /°F /°F)	COD
01	Council Bluffs	USA (IA)	790	25.5 / 565 / 565 (3690/1050/1050)	2007
02	Weston 4	USA (WI)	500	36.2 / 580 / 580 (3800/1076/1076)	2007
03	Comanche 3	USA (CO)	750	26.2 / 570 / 570 (3800/1055/1055)	2009
04	Elm Road 1 & 2	USA (WI)	2 x 600	26.2 / 570 / 570 (3800/1055/1055)	2009
05	Iatan 2	USA (MO)	900	25.5 / 585 / 585 (3686/1085/1085)	2010
06	Genesee 3	Canada	495	25.0 / 570 / 568 (3626/1058/1054)	2005
07	RPP NRW _{60Hz}	USA	800	28.5 / 600 / 610 (4134/1112/1130)	2010
08	Lippendorf	Germany	934	26.7 / 554 / 583 (3873/1029/1081)	1999
09	Boxberg 1	Germany	907	26.6 / 545 / 581 (3860/1013/1078)	2000
10	Niederaussem	Germany	1027	27.5 / 580 / 600 (3989/1076/1112)	2003
11	RPP NRW _{50Hz}	Germany	600	28.5 / 600 / 620 (4134/1112/1148)	2008
12	Boa 2 Neurath	Germany	2 x 1100	26.0 / 595 / 595 (3771/1103/1103)	2010
13	Nordjylland 3	Denmark	411	29.0 / 582 / 580 (4206/1080/1076)	1998
14	Avedoere 2	Denmark	450	30.0 / 580 / 600 (4351/1076/1112)	2002
15	Schwarze Pumpe	Germany	2 x 800	26.8 / 547 / 565 (3742/1017/1078)	1996
16	Tachibana-Wan	Japan	1050	25.9 / 600 / 610 (3756/1112/1130)	2000
17	Hitachi-Naka 1	Japan	1000	25.4 / 604 / 602 (3684/1119/1116)	2003
18	Isogo 1	Japan	600	28.0 / 605 / 613 (4061/1121/1135)	2002
19	Misumi	Japan	1000	25.0 / 600 / 605 (3626/1112/1121)	1998
20	Wangqu	PR China	2 x 600	27.5 / 571 / 569 (3989/1060/1056)	2007
21	Waigaoqiao	PR China	2 x 900	27.9 / 542 / 562 (4047/1008/1044)	2004
22	Zouxian IV	PR China	2 x 1000	27.0 / 600 / 600 (3916/1112/1112)	2008
23	Huaneng	PR China	4 x 1000	26.5 / 600 / 600 (3844/1112/1112)	2008
24	Cogan Creek	Australia	700	26.0 / 540 / 560 (3626/1004/1040)	2008

Pos	Power Plant Name	Country	Power Output MW _{GROSS}	Live Steam MPa /°C /°C (psi /°F /°F)	COD
01	Council Bluffs	USA (IA)	790	25.5 / 565 / 565 (3690/1050/1050)	2007
02	Weston 4	USA (WI)	500	36.2 / 580 / 580 (3800/1076/1076)	2007
03	Comanche 3	USA (CO)	750	26.2 / 570 / 570 (3800/1055/1055)	2009
04	Elm Road 1 & 2	USA (WI)	2 x 600	26.2 / 570 / 570 (3800/1055/1055)	2009
05	Iatan 2	USA (MO)	900	25.5 / 585 / 585 (3686/1085/1085)	2010
06	Genesee 3	Canada	495	25.0 / 570 / 568 (3626/1058/1054)	2005
07	RPP NRW _{60Hz}	USA	800	28.5 / 600 / 610 (4134/1112/1130)	2010
08	Lippendorf	Germany	934	26.7 / 554 / 583 (3873/1029/1081)	1999
09	Boxberg 1	Germany	907	26.6 / 545 / 581 (3860/1013/1078)	2000
10	Niederaussem	Germany	1027	27.5 / 580 / 600 (3989/1076/1112)	2003
11	RPP NRW _{50Hz}	Germany	600	28.5 / 600 / 620 (4134/1112/1148)	2008
12	Boa 2 Neurath	Germany	2 x 1100	26.0 / 595 / 595 (3771/1103/1103)	2010
13	Nordjylland 3	Denmark	411	29.0 / 582 / 580 (4206/1080/1076)	1998
14	Avedoere 2	Denmark	450	30.0 / 580 / 600 (4351/1076/1112)	2002
15	Schwarze Pumpe	Germany	2 x 800	26.8 / 547 / 565 (3742/1017/1078)	1996
16	Tachibana-Wan	Japan	1050	25.9 / 600 / 610 (3756/1112/1130)	2000
17	Hitachi-Naka 1	Japan	1000	25.4 / 604 / 602 (3684/1119/1116)	2003
18	Isogo 1	Japan	600	28.0 / 605 / 613 (4061/1121/1135)	2002
19	Misumi	Japan	1000	25.0 / 600 / 605 (3626/1112/1121)	1998
20	Wangqu	PR China	2 x 600	27.5 / 571 / 569 (3989/1060/1056)	2007
21	Waigaoqiao	PR China	2 x 900	27.9 / 542 / 562 (4047/1008/1044)	2004
22	Zouxian IV	PR China	2 x 1000	27.0 / 600 / 600 (3916/1112/1112)	2008
23	Huaneng	PR China	4 x 1000	26.5 / 600 / 600 (3844/1112/1112)	2008
24	Cogan Creek	Australia	700	26.0 / 540 / 560 (3626/1004/1040)	2008

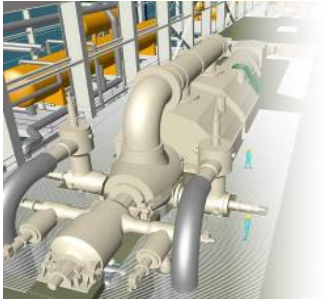

IMTE AG Power Consulting Engineers

www.imteag.com

Boxberg 907 MW USC Power Plant - Germany

26.6 MPa
545 / 581 °C



3860 psi
1013 / 1078 °F

Photographs courtesy
of Siemens Power
Generation AG



Coalgen 2006
© IMTE



IMTE AG Power Consulting Engineers

www.imteag.com

Niederaussem 1027 MW USC Power Plant - Germany

27.5 MPa
580 / 600 °C



3989 psi
1076 / 1112 °F

Photograph courtesy
of Siemens Power
Generation AG



Coalgen 2006
© IMTE



IMTE AG Power Consulting Engineers

www.imteag.com

Schwarze Pumpe 2x800 MW USC Power Plant - Germany

26.8 MPa
547 / 565 °C



3742 psi
1017 / 1078 °F

Coalgen 2006
© IMTE



IMTE AG Power Consulting Engineers

www.imteag.com

Tachibana-Wan 1050 MW SC Power Plant - Japan



25.9 MPa
600 / 610 °C

3756 psi
1112 / 1130 °F

Photographs courtesy
of IHI Ltd

Coalgen 2006

© IMTE



IMTE AG Power Consulting Engineers

www.imteag.com

Shin-Isogo 600 MW USC Power Plant - Japan

28.0 MPa
605 / 613 °C



4061 psi
1121 / 1135 °F

Photographs courtesy
of Hokuriku Electric
Power Co & Siemens
Power Generation AG



Coalgen 2006

© IMTE

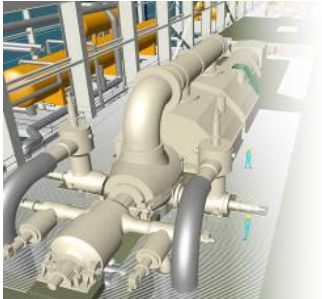

IMTE AG Power Consulting Engineers

www.imteag.com

Misumi 1000 MW SC Power Plant - Japan



25.0 MPa
600 / 605 °C

3626 psi
1112 / 1121 °F

Coalgen 2006

© IMTE

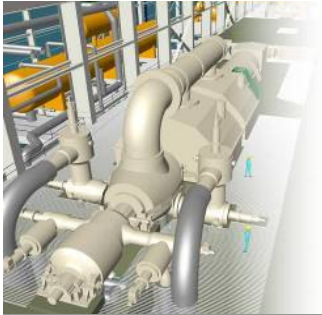

IMTE AG Power Consulting Engineers

www.imteag.com

Waigaoqiao 2x900 MW USC Power Plant—PR China

27.9 MPa
542 / 562 °C



4047 psi
1008 / 1044 °F

Photographs courtesy
of Siemens Power
Generation AG

Coalgen 2006

© IMTE



Power Plants Around the World

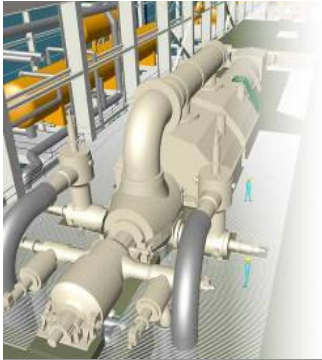

IMTE AG Power Consulting Engineers

www.imteag.com

Huaneng Yuhuan 4x1000 MW USC Power Plant – PR China



26.5 MPa
600 / 600 °C

COD
2008

3844 psi
1112 / 1112 °F

Photographs courtesy
of Ministry of
Construction PR China

Coalgen 2006

© IMTE

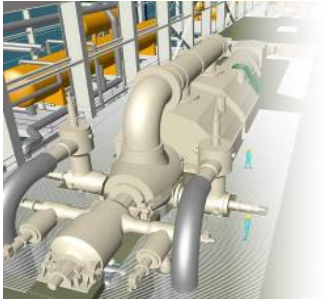

IMTE AG Power Consulting Engineers

www.imteag.com

Kogan Creek 700MW SC Power Plant - Australia



Photograph courtesy of Siemens Power Generation AG

Coalgen 2006

© IMTE

© SIEMENS 2004

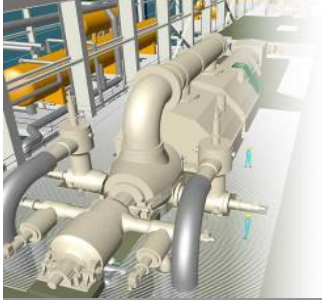

IMTE AG Power Consulting Engineers

www.imteag.com

Kogan Creek 700MW SC Power Plant - Australia

26.0 MPa / 540°C / 560°C



3,626 psi / 1004°F / 1040°F

Photograph courtesy
of Siemens Power
Generation AG

Coalgen 2006

© IMTE

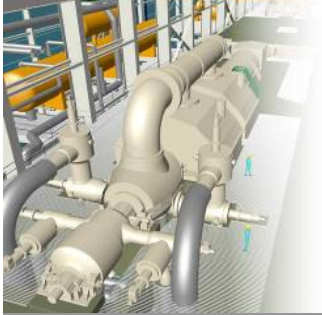

IMTE AG Power Consulting Engineers
www.imteag.com

Summary & Conclusions

Coalgen 2006
© IMTE

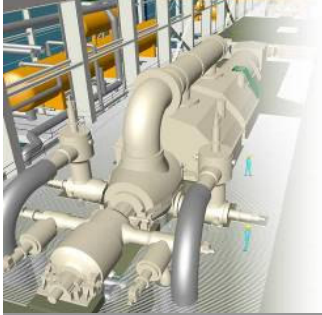

**Most of the coal fired power plants to
be build worldwide during next
decades will be of:-**

**IGCC Technology; and
Pulverized Coal Fired SC/USC
Technology**

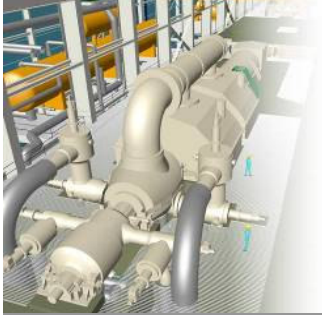

- **Both IGCC and SC & USC Technologies are enjoying a steeply growing market share.**
- **However, IGCC market specifically, is not following this bullish trend yet- Reason is higher investment costs than the cost of SC & USC Technology.**

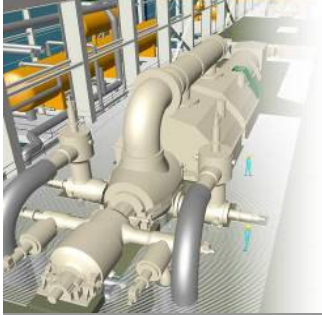

**SC & USC Power Generation
Technology will gain superiority over
conventional (sub-critical) power plants
from the following reasons:-**

Higher Efficiency

Excellent Load Behavior

Compactness

Environmental Friendliness

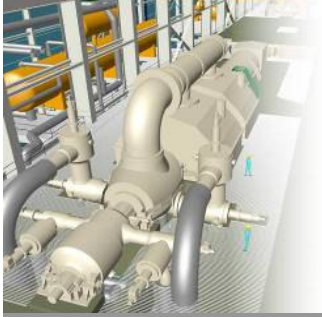

**Current SC pulverized coal based
power plants are working with net
efficiencies in the range of:-**

44 - 46%

7,755 - 7,420Btu/kWh



**Options to increase efficiency above
50 %
6,824 Btu/kWh
in
USC Power Plants
rely on elevated steam conditions as well
as on future improved process and
component quality.**

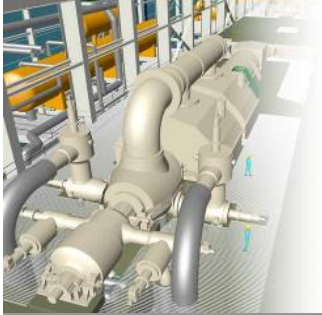

**Steam conditions up to
30 MPa/600 °C/620 °C
4351psi/1112 °F/1148 °F
are achieved using steels with
12 % Cr content**

**Steam conditions up to
31.5 MPa/620 °C/620 °C
4567psi/1148 °F/1148 °F
can be achieved with Austenite
steels.**

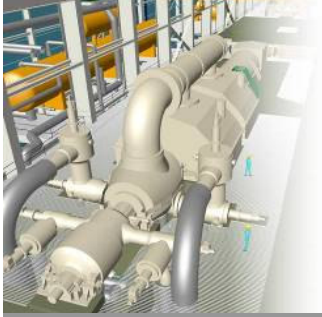

**Nickel-based alloys may permit
35MPa/720 °C/720 °C
5076psi/1328 °F/1328 °F
yielding efficiencies of:-
50 - 52%
6,825-6,562Btu/kWh
in around 2020.**

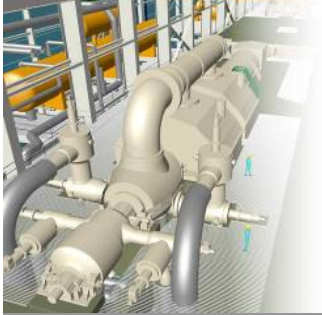

Overall outlook for pulverized coal-fired SC/USC power plant technology is promising and its further growth lies ahead.

Intensity of this growth will depend on the following factors:

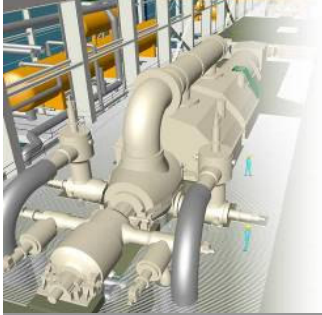

IMTE AG Power Consulting Engineers

www.imteag.com

- **Worldwide acceptance of USC technology**
- **Further development of NG vs. Coal price**
- **Reduction of investment & life cycle costs**
- **Further Improvement of availability & reliability**
- **Efficiency improvement**
- **Further reduction of specific emissions.**

Coalgen 2006

© IMTE

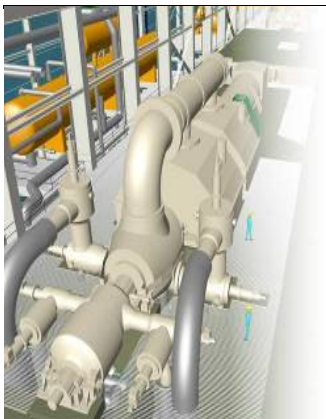

New technologies have an impact on everything — from environmental quality to costs that consumers will ultimately have to pay

THANK YOU

IMTE AG

Power Consulting Engineers, Switzerland

imteag.com